

# ROCK SHOX

POWERED BY SRAM™



(english) technical manual  
part# 95-4015-016-000

---

## **SRAM ORIGINAL PARTS**

### **CAUTION:**

The SRAM Warranty policy does not cover damages caused by the use of non-SRAM parts.

Use only SRAM parts with SRAM components.

Installation of parts and accessories not originally intended could result in less than optimal performance and/or injury.

For in-depth service information on SRAM products, refer to our website at **[www.sram.com](http://www.sram.com)**. Contact your local SRAM distributor or dealer for ordering information.

Information contained in this publication is subject to change at any time without prior notice. Your product's appearance may vary from the diagrams contained in this catalog.

# TABLE OF CONTENTS

<b>Getting Started</b> .....	5
Fork Technology Designation and Oil Volumes .....	6
Tools Needed for Service .....	8
<b>Lower Leg Removal (All Forks)</b> .....	11
<b>Bushing Service (All Forks)</b> .....	13
<b>Damper Service</b> .....	23
<b>Rebound &amp; Turnkey</b>	
(Argyle 302 - Dart 2, 2 with Turnkey, 3 - Domain 302 - Pike 327 - Recon 327/XC, 335/SL - Tora 289, 302) .....	24
<b>Motion Control</b>	
(Argyle 318, 409 - Domain 318 - Lyrik IS - Tora 318 - Totem IS) .....	27
<b>Motion Control</b>	
(BoXXer Race, Team, WC Pike 351, 409, 426, 454 - Reba SL, Race, Team, WC - Recon 351 -Revelation 409, 426) .....	30
<b>Motion Control</b>	
(SID Team, WC) .....	33
<b>Pure Delite</b>	
(SID Race) .....	37
<b>Mission Control</b>	
(Lyrik - Totem) .....	39
<b>Spring Service</b> .....	43
<b>Coil</b>	
(Argyle 302, 318 - Dart 1, 2, 2 (with Turnkey), 3 - Domain 302, 318 - Tora 289, 302, 318) .....	44
<b>Coil</b>	
(BoXXer Race, Team - Recon 327, 335, 351 - Totem) .....	45
<b>Coil U-Turn</b>	
(Domain 302, 318 - Tora 289, 302, 318) .....	46
<b>Coil U-Turn</b>	
(Lyrik, Lyrik IS - Pike 409, 426, 454 - Recon 327, 351 - Revelation 426) .....	47
<b>Solo Air</b>	
(Argyle 409, Recon 335, 351 - Tora 318) .....	48
<b>Solo Air</b>	
(BoXXer WC - Lyrik, Lyrik IS - Recon 327, 335, 351 - Totem) .....	51
<b>Dual Air</b>	
(Pike 409, 426, 454 - Reba SL, Race, Team, WC - Revelation 409, 426) .....	54
<b>Dual Air</b>	
(SID Race, Team, WC) .....	56
<b>Air U-Turn</b>	
(Pike 409, 429, 454 - Reba Race, Team - Revelation 409, 429) .....	58
<b>2-Step Air</b>	
(Lyrik, Lyrik IS - Totem, Totem IS) .....	62
<b>Lower Leg Installation (All Forks)</b> .....	65
<b>i-Ride Spring Service</b> .....	69
<b>Rear Shock Service</b> .....	75
Tools Needed for Service .....	76
Ario, Bar, MC, Pearl .....	77
Monarch .....	79
Vivid .....	82



# **SAFETY FIRST!**

At SRAM Corporation, we care about YOU, our customer. Please, **ALWAYS** wear your safety glasses when servicing your RockShox fork. Protect your eyes! Wear your safety glasses!

# GETTING STARTED

For exploded diagrams and part number information, please refer to the Spare Parts Catalog, which is available on our website at [www.sram.com](http://www.sram.com)

For ordering information, please contact your local distributor or visit our website at [www.sram.com](http://www.sram.com).

Information contained in this publication is subject to change at anytime without prior notice. For the latest technical information, please visit our website at [www.sram.com](http://www.sram.com). Product names used in this manual may be trademarks or registered trademarks of others.



# FORK TECHNOLOGY DESIGNATION AND OIL VOLUMES (ALL FORKS)

The following chart is a complete list of the 2008 RockShox fork line-up. It details the fork model and corresponding damper and spring technology specific to each fork, and the oil volume and weight for each fork leg. It is important to determine the technology used in your fork in order to successfully service it, as this manual is sectioned by technology, rather than forks. If you are unsure of the technology used in your fork, consult your local RockShox dealer for assistance.

	DAMPER TECHNOLOGY (RIGHT LEG)	VOLUME (CC/ML)	OIL WT	VOLUME (CC/ML)	OIL WT	SPRING TECHNOLOGY (LEFT LEG)	VOLUME (CC/ML)	OIL WT	VOLUME (CC/ML)	OIL WT
		UPPER LEG		LOWER LEG			UPPER LEG		LOWER LEG	
ARGYLE 302	REBOUND ONLY	130	5	10	15	COIL	-	-	30	15
ARGYLE 318	MOTION CONTROL	130	5	10	15	COIL	-	-	30	15
ARGYLE 409	MOTION CONTROL	130	5	10	15	SOLO AIR	6	15	15	15
BOXXER RACE / TEAM	MOTION CONTROL	150	5	15	15	COIL	30	15	-	-
BOXXER WORLD CUP	MOTION CONTROL	150	5	15	15	SOLO AIR	6	15	15	15
DART 1	NONE	-	-	20	15	COIL	-	-	20	15
DART 2 (W/TURNKEY)	TURNKEY	93	5	10	15	COIL	-	-	20	15
DART 2	REBOUND ONLY	150	5	-	-	COIL	-	-	20	15
DART 3	TURNKEY	93	5	10	15	COIL	-	-	20	15
DART 29r	TURNKEY	93	5	10	15	COIL	-	-	20	15
DOMAIN 302	REBOUND ONLY	200	5	10	15	COIL	-	-	15	15
DOMAIN 302 COIL U-TURN	REBOUND ONLY	200	5	10	15	COIL U-TURN	-	-	15	15
DOMAIN 318	MOTION CONTROL	200	5	10	15	COIL	-	-	15	15
DOMAIN 318 COIL U-TURN	MOTION CONTROL	200	5	10	15	COIL U-TURN	-	-	15	15
LYRIK COIL U-TURN	MISSION CONTROL	112	5	15	15	U-TURN	-	-	15	15
LYRIK SOLO AIR	MISSION CONTROL	112	5	15	15	SOLO AIR	6	15	15	15
LYRIK 2-STEP	MISSION CONTROL	112	5	15	15	2-STEP	35	2.5	10	15
LYRIK IS COIL U-TURN	MOTION CONTROL IS	112	5	15	15	U-TURN	-	-	15	15
LYRIK IS SOLO AIR	MOTION CONTROL IS	112	5	15	15	SOLO AIR	6	15	15	15
LYRIK IS 2-STEP	MOTION CONTROL IS	112	5	15	15	2-STEP	35	2.5	10	15
PIKE 327 COIL U-TURN	REBOUND ONLY	120	5	15	15	COIL U-TURN	-	-	15	15
PIKE 351 COIL U-TURN	MOTION CONTROL	120	5	15	15	COIL U-TURN	-	-	15	15
PIKE 409 COIL U-TURN	MOTION CONTROL	120	5	15	15	COIL U-TURN	-	-	15	15
PIKE 409 AIR U-TURN	MOTION CONTROL	120	5	15	15	AIR U-TURN	6	15	15	15
PIKE 409 DUAL AIR	MOTION CONTROL	120	5	15	15	DUAL AIR	6	15	15	15
PIKE 426 COIL U-TURN	MOTION CONTROL	120	5	15	15	COIL U-TURN	-	-	15	15
PIKE 426 AIR U-TURN	MOTION CONTROL	120	5	15	15	AIR U-TURN	6	15	15	15
PIKE 426 DUAL AIR	MOTION CONTROL	120	5	15	15	DUAL AIR	6	15	15	15
PIKE 454 COIL U-TURN	MOTION CONTROL	120	5	15	15	COIL U-TURN	6	15	15	15
PIKE 454 AIR U-TURN	MOTION CONTROL	120	5	15	15	AIR U-TURN	-	-	15	15
PIKE 454 DUAL AIR	MOTION CONTROL	120	5	15	15	DUAL AIR	6	15	15	15
REBA SL	MOTION CONTROL	110	5	15	15	DUAL AIR	6	15	15	15
REBA RACE	MOTION CONTROL	110	5	15	15	DUAL AIR	6	15	15	15
REBA RACE AIR U-TURN	MOTION CONTROL	110	5	15	15	AIR U-TURN	6	15	15	15
REBA TEAM	MOTION CONTROL	110	5	15	15	DUAL AIR	6	15	15	15
REBA TEAM AIR U-TURN	MOTION CONTROL	110	5	15	15	AIR U-TURN	6	15	15	15
REBA WORLD CUP (WC)	MOTION CONTROL	110	5	15	15	DUAL AIR	6	15	15	15

## FORK TECHNOLOGY DESIGNATION AND OIL VOLUMES (CONT)

	DAMPER TECHNOLOGY (RIGHT LEG)	VOLUME (CC/ML)	OIL WT	VOLUME (CC/ML)	OIL WT	SPRING TECHNOLOGY (LEFT LEG)	VOLUME (CC/ML)	OIL WT	VOLUME (CC/ML)	OIL WT
		UPPER LEG		LOWER LEG			UPPER LEG		LOWER LEG	
RECON 327/XC SOLO AIR	REBOUND ONLY	120	5	15	15	SOLO AIR	6	15	15	15
RECON 335/SL	TURNKEY	120	5	15	15	COIL	-	-	30	15
RECON 335/SL SOLO AIR	TURNKEY	120	5	15	15	SOLO AIR	6	15	15	15
RECON 351/RACE	MOTION CONTROL	18	5	15	15	COIL	-	-	30	15
RECON 351/RACE COIL U-TURN	MOTION CONTROL	118	5	15	15	COIL U-TURN	-	-	30	15
RECON 351/RACE SOLO AIR	MOTION CONTROL	118	5	15	15	SOLO AIR	6	15	15	15
REVELATION 409 COIL U-TURN	MOTION CONTROL	115	5	15	15	COIL U-TURN	6	15	15	15
REVELATION 409 AIR U-TURN	MOTION CONTROL	115	5	15	15	AIR U-TURN	6	15	15	15
REVELATION 426 DUAL AIR	MOTION CONTROL	115	5	15	15	DUAL AIR	6	15	15	15
REVELATION 426 COIL U-TURN	MOTION CONTROL	115	5	15	15	COIL U-TURN	-	-	30	15
REVELATION 426 AIR U-TURN	MOTION CONTROL	115	5	15	15	AIR U-TURN	6	15	15	15
SID RACE	PURE DELITE	5	15	10	15	DUAL AIR	6	15	10	15
SID TEAM	MOTION CONTROL	-	-	10	15	DUAL AIR	6	15	10	15
SID WORLD CUP (WC)	MOTION CONTROL	-	-	10	15	DUAL AIR	6	15	10	15
TOTEM COIL	MISSION CONTROL	137	5	20	15	COIL	-	-	20	15
TOTEM SOLO AIR	MISSION CONTROL	137	5	20	15	SOLO AIR	6	15	20	15
TOTEM 2-STEP	MISSION CONTROL	137	5	20	15	2-STEP	135	2.5	20	15
TOTEM IS COIL	MOTION CONTROL IS	137	5	20	15	COIL	-	-	20	15
TORA 289	REBOUND ONLY	145	5	15	15	COIL	-	-	20	15
TORA 289	REBOUND ONLY	145	5	15	15	COIL U-TURN	-	-	30	15
TORA 302	TURNKEY	145	5	15	15	COIL	-	-	20	15
TORA 302	TURNKEY	145	5	15	15	COIL U-TURN	-	-	30	15
TORA 318	MOTION CONTROL	145	5	15	15	COIL	-	-	20	15
TORA 318	MOTION CONTROL	145	5	15	15	COIL U-TURN	-	-	20	15
TORA 318	MOTION CONTROL	130	5	15	15	SOLO AIR	6	15	15	15

# TOOLS NEEDED FOR SERVICE (ALL FORKS)

The following chart is a list of the model year 2008 tools needed for service on your RockShox fork. While this chart is intended to be comprehensive, it is still only a guide. The tools required for each step of service are detailed in the text of each service section. Keep in mind your specific fork may not require every tool listed.

TOOLS	LOWER LEG REMOVAL	BUSHING SERVICE	DAMPER SERVICE	SPRING SERVICE	LOWER LEG INSTALLATION
<b>SAFETY/STARTING EQUIPMENT</b>					
SAFETY GLASSES	X	X	X	X	X
APRON	X	X	X	X	X
RUBBER GLOVES	X	X	X	X	X
CLEAN RAGS (LINT FREE)	X	X	X	X	X
OIL PAN	X	X	X	X	X
CLEAN WORK AREA	X	X	X	X	X
BICYCLE STAND	X		X	X	X
BENCH VISE		X			
<b>WRENCHES/PLIERS</b>					
1.5 MM HEX			X		
2 MM HEX				X	
2.5 MM HEX			X	X	X
4 MM HEX	X <sup>1</sup>		X <sup>2</sup>		X <sup>1</sup>
5 MM HEX	X				X
6 MM HEX				X <sup>5</sup>	
8 MM HEX				X <sup>6</sup>	
10 MM SOCKET OR OPEN ENDED WRENCH	X				X
14 MM SOCKET				X <sup>5</sup> , X <sup>6</sup>	
15 MM SOCKET				X	
24 MM SOCKET			X	X	
SOCKET EXTENSION				X <sup>5</sup> , X <sup>6</sup>	
24 MM THIN WRENCH			X <sup>2</sup>		
MISSION CONTROL WRENCH			X <sup>2</sup>		
TORQUE WRENCH			X	X	
SLIP JOINT PLIERS			X <sup>2</sup>		
SNAP RING PLIERS - INTERNAL			X	X	
SNAP RING PLIERS - EXTERNAL			X	X	
<b>MISC TOOLS</b>					
PLASTIC Mallet	X	X	X	X	X
Mallet Drift Tool		X			
LONG DOWEL ROD (PLASTIC OR WOOD)	X	X	X	X	X
FLATHEAD SCREWDRIVER		X		X	
SHARP PICK			X	X	
SHOCK PUMP			X <sup>3</sup>	X	X
SHRADER VALVE CORE TOOL				X <sup>7</sup>	

<sup>1</sup>BoXXer Only

<sup>2</sup>Mission Control Only

<sup>3</sup>SID Race Only

<sup>4</sup>SID Models Only

<sup>5</sup>i-Ride Only

<sup>6</sup>i-Ride with M-10 Star Nut Only

<sup>7</sup>2-Step Air Only



## TOOLS NEEDED FOR SERVICE (CONT)

TOOLS	LOWER LEG REMOVAL	BUSHING SERVICE	DAMPER SERVICE	SPRING SERVICE	LOWER LEG INSTALLATION
MAGNET				X	
RULER			X <sup>3</sup>		X <sup>1</sup>
SID DUAL AIR UPPER TUBE RETAINER TOOL				X <sup>4</sup>	
BUSHING REMOVAL TOOL/PLATE		X			
<b>OIL/LIQUIDS</b>					
2.5, 5, 10 OR 15 WT SUSPENSION OIL		X	X	X	X
GREASE		X	X	X	X
i-RIDE GREASE (Maxima SG-920)				X	
OIL MEASURING DEVICE		X	X	X	X
ISOPROPYL ALCOHOL	X	X	X	X	X
FROSTY COLD BEVERAGE	X	X	X	X	X

<sup>1</sup>BoXXer Only

<sup>2</sup>Mission Control Only

<sup>3</sup>SID Race Only

<sup>4</sup>SID Models Only

<sup>5</sup>i-Ride Only

<sup>6</sup>i-Ride with M-10 Star Nut Only

<sup>7</sup>2-Step Air Only



# LOWER LEG REMOVAL



# LOWER LEG REMOVAL

## (ALL FORKS)

### INTRODUCTION

Removing the lower legs of your fork is the first step in servicing your fork. It allows you access to your fork bushings, damper system and spring system. Once you have removed your fork lower legs, you'll be ready to move onto the next section.

### LOWER LEG REMOVAL INSTRUCTIONS

**NOTE: boXXer ONLY - LOOSEN UPPER CROWN BOLTS WITH A 4M M HEX WRENCH AND REMOVE UPPER CROWN. SPRAY ISOPROPYL ALCOHOL ON UPPER TUBES AND UNDER FRAME BUMPERS. TWIST AND PULL UP TO REMOVE BUMPERS. FINALLY, USE A 4 MM HEX WRENCH TO LOOSEN LOWER CROWN BOLTS AND REMOVE UPPERS FROM CROWN BY TWISTING AND SLIDING EACH UPPER DOWN AND OUT OF CROWN.**

1. Remove the air chamber valve cover cap from the left fork leg top cap. If fork has a negative air chamber, remove the negative air chamber valve cover cap from the bottom of the left fork leg.
2. Depress schrader valve and release all air from the air chamber. If fork has a negative air chamber, start with the negative air chamber first, then proceed to the positive air chamber.
3. Pull external rebound adjuster knob and remove from the right shaft bolt.
4. Use a 5 mm hex wrench to loosen both shaft bolts 3 to 4 turns. For Dual Air equipped forks, use a 10 mm socket (or open end) wrench to loosen and unthread the Dual Air shaft nut just past the threaded shaft end.
5. Use a plastic mallet to gently tap each shaft bolt free from its press-fit to the lower leg and use your fingers to remove shaft bolts/nut completely.
6. Remove the lower leg assembly from fork by firmly pulling it downward, holding onto both legs or the brake arch.
7. Use oil pan to drain excess oil from lower leg assembly.
8. Spray isopropyl alcohol on and into the lower leg assembly. Wipe the lower legs clean, then wrap a clean rag around a dowel and clean the inside of each lower leg (not pictured).



1

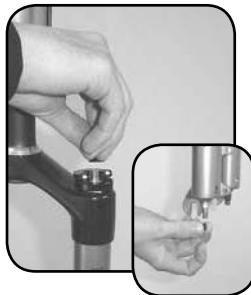

2



3



4



5



6

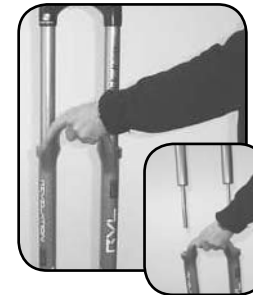

7



# BUSHING SERVICE



# BUSHING SERVICE

## (ALL FORKS)

### INTRODUCTION

Suspension fork bushings are considered "wear and tear" parts and require regular maintenance, depending on the frequency of riding, riding terrain, rider body weight, and type of fork. The more you ride, the more frequently your bushings need to be replaced. The following chapter covers Dust & Oil Seal removal, Bushing removal, Bushing installation, and Dust & Oil Seal installation.

At this point you should already have the lowers removed from your fork. If not, you will need to return to the Lower Leg Removal section of this manual and follow the instructions for removing your fork lowers.

### SYMPTOMS OF WORN BUSHINGS

Symptoms of worn bushings that need to be replaced include, a "knocking" sound from the fork when riding, and/or the headset may feel loose when it isn't.

### TWO METHODS OF CHECKING FOR LOOSE BUSHINGS

#### Method 1: On-Bike check

1. Compress fork 5 times to circulate lower leg lube (not pictured).
2. Hold the front brake lever tight and rock the bike back and forth. If the fork feels like it's "knocking", or the headset feels loose, proceed to steps 2 and 3.
3. Check the fork: wrap your fingers around the dust seal and upper tube area. Rock the bike back and forth again. Listen and feel if there is any play between the upper tube and the dust seal. If so, the bushings are loose.
4. Check the headset: wrap your fingers around the headset upper cup or lower cup/race areas. Holding the brake, rock the bike back and forth and feel if the headset is loose. If so, tighten the headset and check again.

2



3



4



#### Method 2: Off-Bike check

1. Compress fork 5 times to circulate lower leg lube (not pictured).
2. Hold the fork crown tight in one hand and the brake arch in the other hand. Try and move the brake arch back and forth. If you can feel any play, or if the fork feels like it's "knocking", the bushings are loose.

**NOTE: YOU MAY WISH TO BRACE THE FORK ON A TABLE OR ON THE FLOOR TO STEADY IT.**

2



## DUST & OIL SEAL REMOVAL (ALL FORKS)

1. Remove the dust seal using a medium to large flat-head screwdriver to carefully pry it from the lower leg.

**NOTE: NOT ALL FORKS CONTAIN A FOAM RING. IF YOUR FORK DOES NOT HAVE A FOAM RING, PLEASE MOVE ON TO STEP 3.**

2. Remove the oil foam ring with your fingers.
- NOTE: NOT ALL FORKS CONTAIN AN INNER OIL SEAL. IF YOUR FORK DOES NOT HAVE AN INNER OIL SEAL, PLEASE MOVE ON TO THE NEXT SECTION, BUSHING REMOVAL.**

3. Remove the inner oil seal, located just below the dust seal using a flat head screwdriver. To protect the lower leg paint, place a rag in between the lower leg and the screwdriver.

**NOTE: THE DUST SEAL ELIMINATES THE NEED TO REPLACE THE OIL SEAL.**

**NOTE: ALL DART FORKS AND TORA 289, 302 DO NOT HAVE SERVICEABLE BUSHINGS, PLEASE MOVE ON TO DUST & OIL SEAL INSTALLATION.**

1



2



3



## BUSHING REMOVAL

(ALL ARGYLE - BOXXER - DOMAIN - LYRIK - PIKE - REBA - RECON - REVELATION - SID - TOTEM & TORA 318)

1. Clamp bushing removal handle/puller tool into bench vise tightly.
2. Install the correct bushing removal plate onto handle end and secure with handle plate screw.
  - 28 mm plate (SID)
  - 32 mm plate (Argyle, BoXXer, Pike, Reba, Recon, Revelation, Tora)
  - 35 mm plate (Domain, Lyrik)
  - 40 mm plate (Totem)

1



2



3

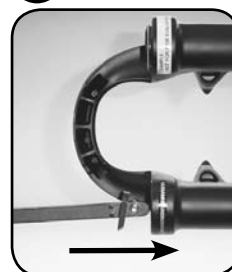

3. Slide the removal plate into the lower leg past the upper bushing. The removal plate pivots when inserted. Pull lower leg away from puller tool and hook the flat end of the plate secure under the bushing. When the plate is secure under bushing, begin to remove.

4



4. Use a plastic mallet to firmly and squarely hit the top of the lower leg on the flat dust seal surface area until upper bushing pulls free.

**IMPORTANT: DO NOT HIT THE BRAKE ARCH TO REMOVE THE BUSHING. THIS CAN DAMAGE YOUR FORK.**

5. To pull the lower bushing free from the lower leg, slide the removal plate past the lower bushing and hook the flat end of the plate secure under the bushing. Again, firmly and squarely hit the top of the lower leg on the flat dust seal surface area until the lower bushing pulls free. Longer lower bushings may require more force.
6. Return to Step 3 and repeat for the other fork leg.

5



7. Spray isopropyl alcohol inside lower legs. Wrap a clean rag around a dowel and clean the inside of the lower legs (not pictured).

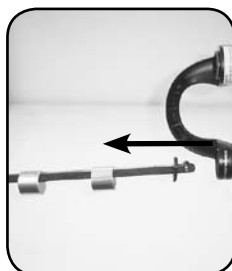

## BUSHING INSTALLATION - 28 MM UPPER TUBE DIAMETER (SID)

### LOWER BUSHING INSTALLATION WITH BUSHING SIZE:

#### 28 MM x 20 MM (SID)

1. Clamp 28 mm bushing installation tool into bench mounted vise, allowing 1" of overhang.
2. Slide the lower bushing sleeve (131.25 mm long, brushed aluminum) onto bushing installation post.
3. Slide lower bushing onto top of lower bushing installation sleeve.
4. Slide lower leg over installation post and rest on top of lower bushing.
5. Insert the mallet drift tool into the lower leg shaft hole and hold in place with one hand. Using a plastic mallet, hit the mallet drift tool to press the bushing into the lower leg.
6. Continue to hit the mallet drift tool until the lower leg dust seal ridge is level with the top of the installation post spacer.
7. Remove lower leg from tool and inspect the fit of the lower bushing by sliding one upper tube into the lower leg. Hold lower leg horizontally and release. Lower leg should swing 90° down and stop (not pictured).

**NOTE: IF LOWER LEG FEELS TIGHT OR DOES NOT MOVE AT ALL, SLIDE LOWER LEG BACK ONTO BUSHING INSTALLATION POST AND ROCK SIDE TO SIDE TO LOOSEN FIT.**

8. Return to step 1 and repeat for other leg.

### UPPER BUSHING INSTALLATION WITH BUSHING SIZE:

#### 28 MM x 10 MM (SID)

9. Remove lower bushing installation sleeve from bushing installation post.
10. Slide 10 mm then 5 mm upper bushing installation spacers onto bushing installation post.
11. Slide upper bushing onto bushing installation post, on top of the 5 mm spacer.
12. Slide lower leg over installation post and rest on top of upper bushing.
13. Insert mallet drift tool into the lower leg shaft hole and hold in place. Using a plastic mallet, hit the mallet drift tool to press the bushing into the lower leg.
14. Continue to hit the mallet drift tool until the lower leg stops moving.
15. Remove lower leg from tool and inspect the fit of the upper bushing by sliding one upper tube into the lower leg. Hold lower leg horizontally and release. Lower leg should swing 90° down and stop (not pictured).

**NOTE: DO NOT PRESS BUSHING BELOW BORE STEP.**

**NOTE: IF LOWER LEG FEELS TIGHT OR DOES NOT MOVE AT ALL, SLIDE LOWER LEG BACK ONTO BUSHING INSTALLATION POST AND ROCK SIDE TO SIDE TO LOOSEN FIT.**

16. Return to Step 9 and repeat for other leg.

1



2

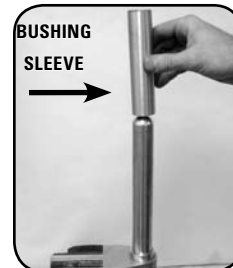

3

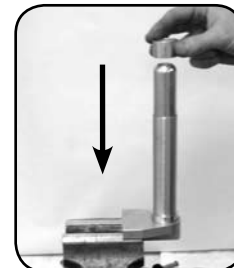

4



5



6



9

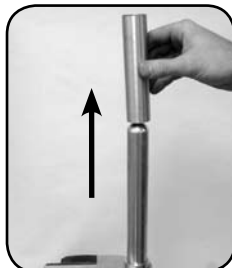

10

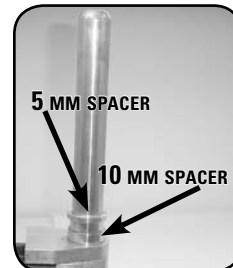

11

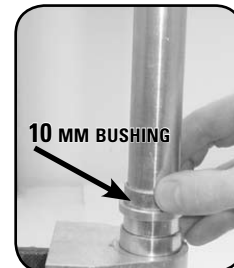

12



13



14





**BUSHING INSTALLATION**  
**32 MM UPPER TUBE DIAMETER (ARGYLE - PIKE - REBA - RECON - REVELATION - TORA 318)**  
**32 MM UPPER TUBE DIAMETER (BOXXER)**

**LOWER BUSHING INSTALLATION WITH BUSHING SIZE:**  
**32 MM X 30 MM - SLOTTED (ARGYLE, PIKE, REBA, RECON, REVELATION, TORA 318)**

**32 MM X 76 MM - NON-SLOTTED (BOXXER)**

1. Clamp 32 mm bushing installation tool into bench mounted vise.
2. Slide lower bushing installation spacer onto bushing installation post.  
**NOTE: RECON, REVELATION, AND TORA 318 USE THE SHORT SPACER IN THIS STEP.**
3. Slide the lower bushing sleeve onto bushing installation post.
4. Recon, Revelation, Tora 318 Only: Slide the tall lower bushing spacer onto the bushing installation post.
5. Slide lower bushing onto the top of the lower installation sleeve.  
**NOTE: BOXXER LOWER BUSHING IS NOT SLOTTED.**
6. Slide lower leg over installation post and rest on top of lower bushing.
7. Insert mallet drift tool into the lower leg shaft hole and hold in place. Using a plastic mallet, hit the mallet drift tool to press the bushing into the lower leg.
8. Continue to hit the mallet drift tool, until the lower leg dust seal ridge is level with the top of the installation post spacer. You will feel it stop as the bushing is "set" in the lower leg.
9. Remove lower leg from tool and inspect the fit of the lower bushing by sliding one upper tube into the lower leg. Hold lower leg 90° horizontally and release. Lower leg should swing 45° down and stop (not pictured).  
**NOTE: IF LOWER LEG SWINGS TOO FREELY, REPEAT STEP 8. IF LOWER LEG FEELS TIGHT OR DOES NOT MOVE AT ALL, SLIDE LOWER LEG BACK ONTO BUSHING INSTALLATION POST AND ROCK SIDE TO SIDE TO LOOSEN FIT.**
10. Return to Step 1 and repeat for other leg.

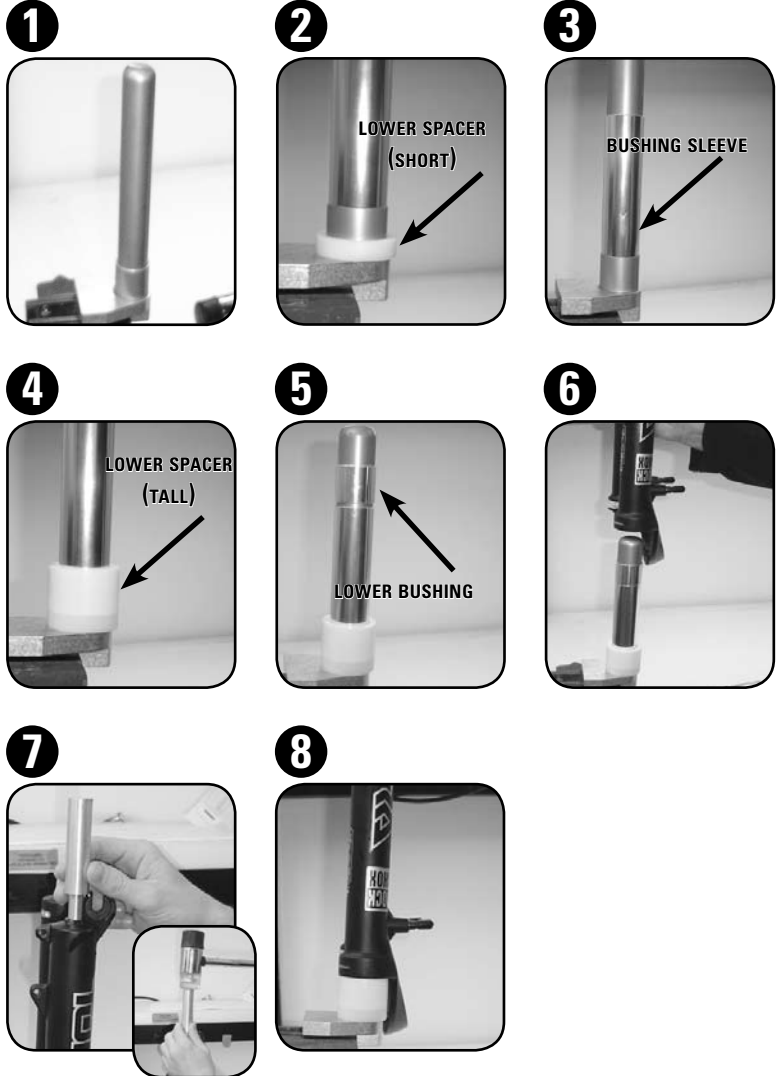

**BUSHING INSTALLATION (CONT)**  
**32 MM UPPER TUBE DIAMETER (ARGYLE - PIKE - REBA - RECON - REVELATION - TORA 318)**  
**32 MM UPPER TUBE DIAMETER (BOXXER)**

UPPER BUSHING INSTALLATION WITH BUSHING SIZE:  
**32 MM X 30 MM NON-SLOTTED (ARGYLE, PIKE, REBA, RECON, REVELATION, TORA 318)**

**32 MM X 10 MM - NON-SLOTTED (BOXXER)**

11. Remove lower bushing sleeve (and tall lower bushing spacer for Recon, Revelation, and Tora 318). Leave only the lower bushing spacer on bushing installation tool.
12. Slide upper bushing onto bushing installation post.
13. Slide lower leg over installation post, and rest on top of the upper bushing.
14. Insert mallet drift tool into the lower leg shaft hole and hold in place. Using a plastic mallet, hit the mallet drift tool to press the upper bushing into lower leg.
15. Continue to hit the mallet drift tool until the lower leg rests flush on top of the install spacer. You will feel it stop as the bushing is "set" in the lower leg. The top of the bushing should be flush/level with oil seal step in the lower leg.
16. Remove lower leg from tool and inspect the fit of the lower bushing by sliding one upper tube into the lower leg. Hold lower leg 90° horizontally and release. Lower leg should swing 45° down and stop (not pictured).

**NOTE: IF LOWER LEG SWINGS TOO FREELY, REPEAT STEP 15. IF LOWER LEG FEELS TIGHT OR DOES NOT MOVE AT ALL, SLIDE LOWER LEG BACK ONTO BUSHING INSTALLATION POST AND ROCK SIDE TO SIDE TO LOOSEN FIT.**

17. Return to Step 11 and repeat for other leg.

**11**

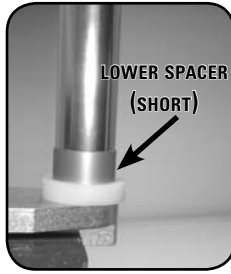

**12**



**13**



**14**



**15**



## BUSHING INSTALLATION

### 35 MM UPPER TUBE DIAMETER (DOMAIN - LYRIK)

### 40 MM UPPER TUBE DIAMETER (TOTEM)

#### LOWER BUSHING INSTALLATION WITH BUSHING SIZE:

**35MM X 30 MM - SLOTTED (DOMAIN, LYRIK)**

**40 MM X 30 MM - SLOTTED (TOTEM)**

1. Clamp 32 mm bushing installation tool into bench mounted vise.
2. Slide bushing installation tool adapter over bushing installation post.
3. Slide lower bushing sleeve onto the adapter.
4. Slide lower bushing onto the adapter.
5. Slide lower leg over installation post and rest on top of lower bushing.
6. Insert mallet drift tool into the lower leg shaft hole and hold in place. Using a plastic mallet, hit the mallet drift tool to press the bushing into the lower leg.
7. Continue to hit the mallet drift tool, until the lower leg dust seal ridge is level with the top of the installation post spacer. You will feel the stopping point as the bushing is "set" into the lower leg.
8. Remove lower leg from tool and inspect the fit of the lower bushing by sliding one upper tube into the lower leg. Hold lower leg 90° horizontally and release. Lower leg should swing 45° down and stop (not pictured).

**NOTE: IF LOWER LEG SWINGS TOO FREELY, REPEAT STEP 7. IF LOWER LEG FEELS TIGHT OR DOES NOT MOVE AT ALL, SLIDE LOWER LEG BACK ONTO BUSHING INSTALLATION POST AND ROCK SIDE TO SIDE TO LOOSEN FIT.**

9. Return to Step 1 and repeat for other leg.

#### UPPER BUSHING INSTALLATION WITH BUSHING SIZE:

**35 MM X 30 MM - NON SLOTTED (DOMAIN, LYRIK)**

**40 MM X 30 MM - NON SLOTTED (TOTEM)**

10. Remove lower bushing sleeve from the adapter and slide upper bushing onto the adapter.
11. Slide lower leg over installation post, and rest on top of the upper bushing.
12. Insert mallet drift tool into the lower leg shaft hole and hold in place. Using a plastic mallet, hit the mallet drift tool to press the upper bushing into lower leg.
13. Continue to hit the mallet drift tool until the lower leg rests flush on top of the install spacer. You will feel it stop as the bushing is "set" in the lower leg. The top of the bushing should be flush/level with oil seal step in the lower leg.

**1**



**2**



**3**

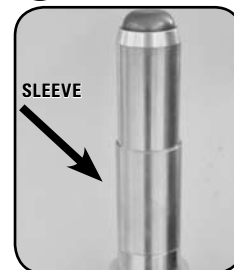

**4**

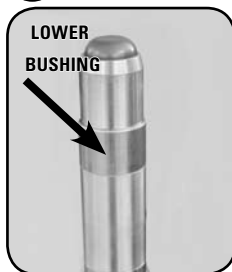

**5**



**6**

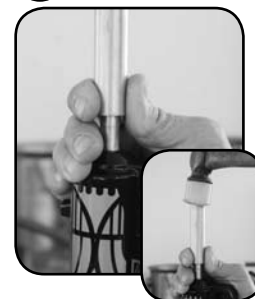

**7**



**10**



**11**



**12**

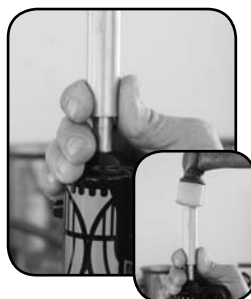

**13**



**BUSHING INSTALLATION (CONT)**  
**35 MM UPPER TUBE DIAMETER (DOMAIN - LYRIK)**  
**40 MM UPPER TUBE DIAMETER (TOTEM)**

**UPPER BUSHING INSTALLATION WITH BUSHING SIZE:**

**35 MM X 30 MM - NON SLOTTED (DOMAIN, LYRIK)**

**40 MM X 30 MM - NON SLOTTED (TOTEM)**

14. Remove lower leg from tool and inspect the fit of the lower bushing by sliding one upper tube into the lower leg. Hold lower leg 90° horizontally and release. Lower leg should swing 45° down and stop (not pictured).

**NOTE: IF LOWER LEG SWINGS TOO FREELY, REPEAT STEP 8.**

**IF LOWER LEG FEELS TIGHT OR DOES NOT MOVE AT ALL, SLIDE LOWER LEG BACK ONTO BUSHING INSTALLATION POST AND ROCK SIDE TO SIDE TO LOOSEN FIT.**

15. Return to Step 10 and repeat for other leg.

## FOAM RING & DUST SEAL INSTALLATION (SID)

### FOAM RING AND DUST SEAL INSTALLATION

1. Soak new foam rings in suspension oil.
2. Slide dust seal installation tool over the 28 mm bushing installation tool. It should sit flush with the base of the installation tool.
3. Slide new dust seal over bushing installation tool and fit on top of dust seal installation tool.  
**NOTE: DUST SEAL SHOULD BE INSTALLED ENERGIZER SPRING SIDE DOWN.**
4. Slide oil-saturated foam ring over bushing installation tool and fit on top of dust seal. Seat the foam ring inside the under cavity of the dust seal. Wipe excess oil off the dust seal with a clean rag.
5. Slide lower leg onto bushing installation tool, on top of new dust seal. Insert mallet drift tool into the lower leg shaft hole and hold in place. Using a plastic mallet, hit the mallet drift tool until dust seal seats inside lower leg, flush with the top of the lower leg dust seal step.
6. Dust seal should be press-fit snug into the lower leg, with little to no gap showing.
7. Return to Step 1 and repeat for other leg.

1



2



3



4

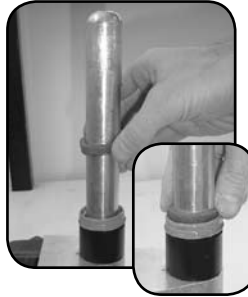

5



6



## FOAM RING & DUST SEAL INSTALLATION (REBA - RECON - REVELATION - TORA 318)

### FOAM RING INSTALLATION

1. Soak new foam rings in suspension oil.
2. Insert new oil-saturated foam ring into lower leg.

### DUST SEAL INSTALLATION

3. Insert new dust seal into the wide end of the dust seal installation tool.
4. Insert dust seal into lower leg and press straight down and evenly to seat into lower leg.
5. Dust seal should be press-fit snug and flush into lower leg.  
**NOTE: CHECK FOAM RING UNDER DUST SEAL. FOAM RING SHOULD NOT PROTRUDE FROM DUST SEAL. IF SO, ADJUST FOAM RING INSIDE LOWER LEG, FLUSH ON ALL SIDES.**
6. Return to Step 1 and repeat for other leg.

1



2



3



4



5



## FOAM RING, DUST SEAL & OIL SEAL INSTALLATION (ARGYLE - BOXXER - DOMAIN - LYRIK - PIKE - REBA - TOTEM)

### OIL SEAL INSTALLATION

1. Apply grease or suspension oil to the inside of the lower leg oil seal counter-bore.
2. Insert the new oil seal onto the stepped end of the oil/dust seal installation tool.
3. Using the oil/dust seal installation tool, insert the oil seal down and into the oil step in the lower leg. Apply pressure on all sides of the oil seal to seat it into place.

1



2



3



### FOAM RING INSTALLATION

**NOTE: FOR DOMAIN, LYRIK, AND TOTEM, PLEASE MOVE ON TO DUST SEAL INSTALLATION, STEP 6.**

4. Soak new foam rings in suspension oil.
5. Insert new oil-saturated foam ring into lower leg on top of oil seal.

4



5



6



### DUST SEAL INSTALLATION

6. Insert new dust seal into the pocketed end of the oil/dust seal installation tool.
7. Using the oil/dust installation tool, insert dust seal into lower leg. Apply pressure on all sides of the dust seal to seat it into place.
8. Dust seal should be press-fit snug and flush into lower leg.

7



8



**NOTE: CHECK FOAM RING UNDER DUST SEAL. FOAM RING SHOULD NOT PROTRUDE FROM DUST SEAL. IF SO, ADJUST FOAM RING INSIDE LOWER LEG, FLUSH ON ALL SIDES.**

9. Return to Step 1 and repeat for other leg.

## COMPLETING BUSHING SERVICE (ALL FORKS)

Complete the bushing service of your fork by detailing the lower legs. Spray isopropyl alcohol on entire lower leg assembly and wipe with a clean rag. Check the decals on your fork and replace if necessary.

**THIS CONCLUDES THE BUSHING SERVICE FOR YOUR FORK. YOU DID A GREAT JOB! YOU ARE NOW READY TO MOVE ON TO THE NEXT SECTION: DAMPER SERVICE. ENJOY!**

# DAMPER SERVICE



# REBOUND & TURNKEY DAMPER SERVICE

(ARGYLE 302 - DART 2, 3 - DOMAIN 302 - PIKE 327 - RECON 327, 335, SL, XC - TORA 289, 302)

## INTRODUCTION

At this point you should already have the lowers removed from your fork. If not, you will need to return to the Lower Leg Removal section of this manual and follow the instructions for removing your fork lowers.

## DAMPER REMOVAL/SERVICE INSTRUCTIONS

**NOTE: FOR DART 2, AND TORA 289 PLEASE SKIP STEP 1 AND MOVE TO STEP 2.**

1. Remove external snap ring from compression adjuster knob using external snap ring pliers and remove compression adjuster knob and o-ring.

**OR**

If fork is equipped with a remote compression lockout feature, remove external snap ring from compression adjuster spool using external snap ring pliers and remove compression adjuster spool and white top cap shield.

2. Unthread compression damper top cap with a 24 mm socket wrench.

**NOTE: FOR ARGYLE 302, DART 2, DOMAIN 302, AND TORA 289 PLEASE MOVE TO STEP 5.**

3. Remove compression damper by pulling up and gently rocking side to side. If fork is equipped with a remote lockout feature, be sure to remove the remote compression damper cable-stop clamp; which is located under the compression damper top cap. Once removed, clean upper tube threads with a rag.

4. Replace compression damper top cap o-ring by gently pinching o-ring to remove. Apply a few drops of suspension oil to new o-ring and re-install.

5. Remove fork from bicycle stand and pour remaining oil into pan.

**NOTE: FOR DART 2, THIS COMPLETES THE REMOVAL PROCEDURES, PLEASE MOVE TO STEP 10.**

6. Turn fork upside down and push rebound damper shaft through shaft guide. Use a long dowel rod to help push damper piston past upper tube threads and remove from upper tube.

7. Remove rebound damper o-ring and damper inner seal-head o-ring (located in the bottom of the upper tube). Apply fresh grease to new o-rings and re-install.

**IMPORTANT: IF USING A PICK TO REMOVE INNER SEAL HEAD O-RING, DO NOT SCRATCH O-RING GLAND. SCRATCHES MAY CAUSE OIL TO LEAK.**

**1**



**OR**



**2**



**3**

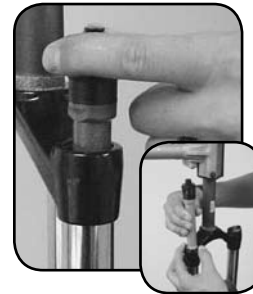

**4**



**5**



**6**



**7**





## OPTIONAL - COMPRESSION DAMPER UPGRADE: NON-REMOTE TO REMOTE ADJUST

Upgrading from a non-remote compression adjust fork to a remote compression adjust (from a crown mounted adjuster knob to a remote PopLoc or PushLoc lever adjuster), requires replacing the non-remote compression damper with a remote compression damper and cable-stop clamp. The remote return spring is integrated into the compression damper and is required for use with the PopLoc and PushLoc remote lever assembly.

### DAMPER INSTALLATION INSTRUCTIONS

8. Clamp fork back into bicycle stand and apply a light film of grease to upper tube threads. Insert rebound damper back into right side of upper tube, shaft first and press piston into upper tube past tube threads.

9. Push rebound damper into upper tube using a long dowel rod. Guide rebound damper shaft through damper seal head at the bottom of the upper tube and pull shaft through by hand into the fully extended position.

10. Measure and pour 5wt suspension oil into the upper tube using the volumes listed in the chart at right.

**NOTE: FOR DART 2 AND TORA 289 PLEASE MOVE TO STEP 12.**

**IMPORTANT: OIL VOLUME IS CRITICAL. TOO MUCH OIL REDUCES AVAILABLE TRAVEL, WHICH CAN LEAD TO FORK DAMAGE FROM COMPRESSION BOTTOM OUT. TOO LITTLE OIL DECREASES DAMPING PERFORMANCE.**

11. Remote Only: Position cable-stop clamp in the 10 o'clock position around the upper tube hole on the crown prior to inserting compression damper. Grease upper tube threads liberally then insert compression damper into upper tube. Press down and twist to work damper into upper tube. Be careful not to damage o-ring seals on upper tube threads.

12. Press top cap down into upper tube threads and hand tighten. Using a 24 mm socket wrench, tighten to 60 in/lbs.

**NOTE: FOR DART 2 AND TORA 289, THIS COMPLETES THE INSTALLATION INSTRUCTIONS. YOU ARE READY TO MOVE ON TO THE NEXT SECTION IN THE MANUAL: SPRING SERVICE.**

8

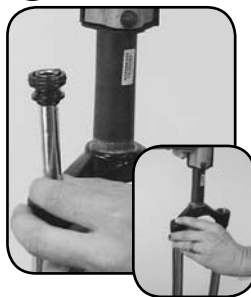

9

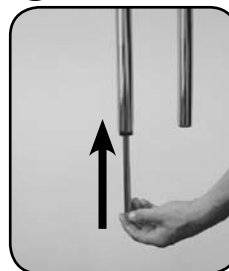

10



11



12



FORK	OIL VOLUME (±5cc/ML)
ARGYLE 302	130cc/ML
DART 2	150cc/ML
DART 2 (WITH TURNKEY)	93cc/ML
DART 3	93cc/ML
DOMAIN 302	200cc/ML
PIKE 327	120 cc/ML
RECON 327, XC	120cc/ML
RECON 335, SL	120cc/ML
TORA 289	145cc/ML
TORA 302	145cc/ML

## DAMPER INSTALLATION INSTRUCTIONS (CONT)

**NOTE: TURN COMPRESSION ADJUSTER HEX COUNTER-CLOCKWISE TO THE OPEN POSITION.**

13. Place compression adjuster knob onto compression damper top cap with the knob dial set in the 3 o'clock position. Using external snap ring pliers, secure the compression adjuster knob with a new snap ring.

**OR**

If fork is equipped with a remote compression lockout feature, place remote spool onto compression damper top cap with the cable set screw in the 3 o'clock position. Using external snap ring pliers, secure the remote spool with a new snap ring.

13



**OR**



**THIS CONCLUDES THE DAMPER SERVICE FOR YOUR FORK. YOU DID A GREAT JOB! YOU ARE NOW READY TO MOVE ON TO THE NEXT SECTION: SPRING SERVICE. ENJOY!**

# MOTION CONTROL DAMPER SERVICE

(ARGYLE 318, 409 - DOMAIN 318 - LYRIK IS - TORA 318 - TOTEM IS)

## INTRODUCTION

At this point you should already have the lowers removed from your fork. If not, you will need to return to the Lower Leg Removal section of this manual and follow the instructions for removing your fork lowers.

## DAMPER REMOVAL/SERVICE INSTRUCTIONS

**NOTE: FOR ARGYLE 318 AND 409, IT IS NOT NECESSARY TO REMOVE THE MOTION CONTROL KNOB, PLEASE SKIP STEP ONE AND MOVE TO STEP 2.**

1. Remove external snap ring from compression adjuster knob using external snap ring pliers and remove compression adjuster knob and o-ring seal.

**OR**

If fork is equipped with a remote compression lockout feature, remove external snap ring from compression adjuster spool using external snap ring pliers and remove compression adjuster spool and white top cap seal.

**OR**

If fork is equipped with Motion Control IS, use a 2 mm hex to remove screw from compression the adjuster knob. Remove compression adjuster knob (not pictured).

2. Unthread compression damper top cap with a 24 mm socket wrench.
3. Remove compression damper from upper tube/crown by pulling up and gently twisting side to side. If fork is equipped, be sure to remove the remote compression damper cable-stop clamp; which is located under the compression damper top cap. Once removed, clean upper tube threads with a rag.
4. With a sharp pick, remove the compression damper top cap o-ring (located at the top of the damper) and the compression damper seal (located at the bottom of the damper). Apply a few drops of suspension oil to the new o-ring and seal and install.

**IMPORTANT: IF USING A PICK TO REMOVE INNER SEAL HEAD O-RING, DO NOT SCRATCH O-RING GLAND. SCRATCHES MAY CAUSE OIL TO LEAK.**

5. Remove fork from bicycle stand and pour remaining oil into pan.
6. Turn fork upside down. Push rebound damper shaft into upper tube/seal head and remove rebound damper from upper tube.
7. Remove rebound damper glide ring and inner seal head o-ring. Apply fresh grease to new o-rings and re-install.

**1**



**OR**



**2**



**3**



**4**

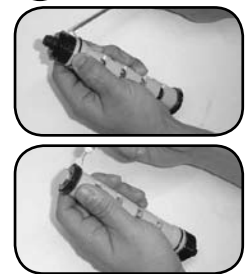

**5**



**6**

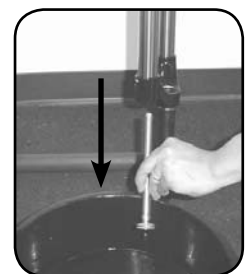

**7**

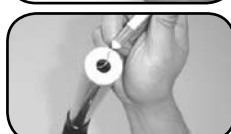

## OPTIONAL - COMPRESSION DAMPER UPGRADE: NON-REMOTE TO REMOTE ADJUST (TORA 318 ONLY)

Upgrading from a non-remote compression adjust fork to a remote compression adjust (from a crown mounted adjuster knob to a remote PopLoc or PushLoc lever adjuster), requires replacing the non-remote compression damper with a remote compression damper and cable-stop clamp. The remote return spring is designed into the compression damper and is required for use with the PopLoc and PushLoc remote lever assembly.

### DAMPER INSTALLATION INSTRUCTIONS

8. Clamp fork back into bicycle stand. Insert rebound damper back into right side of upper tube, shaft first. Guide rebound damper through damper seal head at bottom of upper tube and pull through.
9. Thread shaft bolt into rebound damper shaft end and pull rebound damper shaft down through seal head into fully extended position.
10. Measure and pour 5wt suspension oil into the upper tube, through the crown using the following volumes:

FORK	OIL VOLUME (±5cc/ML)
ARGYLE 318	130cc/ML
ARGYLE 409	130 cc/ML
DOMAIN 318	200 cc/ML
TORA 318	145 cc/ML

**IMPORTANT: OIL VOLUME IS CRITICAL. TOO MUCH OIL REDUCES AVAILABLE TRAVEL, WHICH CAN LEAD TO FORK DAMAGE FROM COMPRESSION BOTTOM OUT. TOO LITTLE OIL DECREASES DAMPING PERFORMANCE.**

11. Remote Only: Slide compression damper through cable-stop clamp prior to insertion. Position the cable-stop clamp in the 10 o'clock position on the crown. Grease upper tube threads liberally, then insert compression damper into upper tube. Press down and twist to work damper into upper tube.
12. As soon as the damper seal passes through the upper tube threads, pull the damper up slightly, then push back down. The compression damper should slide up and down easily, indicating the seal in the proper position, and not folded over. Repeat procedure until the compression damper slides up and down easily. Then press the compression damper down until the upper o-ring contacts the upper tube threads.

8



9

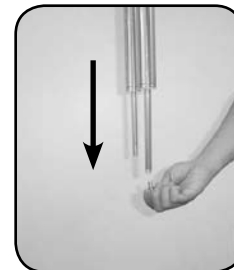
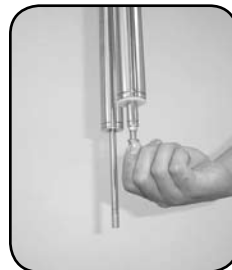

10



11

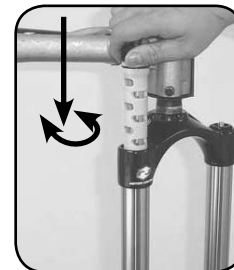

12

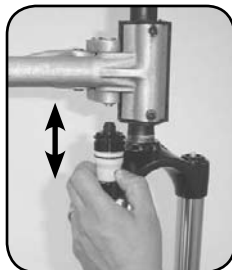

## DAMPER INSTALLATION INSTRUCTIONS (CONT)

13. Turn the damper clockwise and thread into the upper tube. Be careful not to damage the upper damper o-ring. Continue to thread top cap down into upper tube threads and hand tighten. Using a 24 mm socket wrench, tighten to 60 in/lbs.

**NOTE: FOR ARGYLE 318 AND 409 THIS COMPLETES THE INSTALLATION PROCESS.**

**NOTE: TURN COMPRESSION ADJUSTER HEX COUNTER-CLOCKWISE TO THE OPEN POSITION.**

14. Place compression adjuster knob onto compression damper top cap with the knob dial set in the 3 o'clock position. Using external snap ring pliers, secure the compression adjuster knob with a new snap ring.

**OR**

If fork is equipped with a remote compression lockout feature, place remote spool onto compression damper top cap with the cable set screw in the 3 o'clock position. Using external snap ring pliers, secure the remote spool with a new snap ring.

**THIS CONCLUDES THE DAMPER SERVICE FOR YOUR FORK. YOU DID A GREAT JOB! YOU ARE NOW READY TO MOVE ON TO THE NEXT SECTION: SPRING SERVICE. ENJOY!**

13



14



OR



# MOTION CONTROL DAMPER SERVICE

(BOXXER RACE, TEAM, WC - PIKE 409, 426, 454 - REBA SL, RACE, TEAM, WC - RECON 351 - REVELATION 409, 426)

## INTRODUCTION

At this point you should already have the lowers removed from your fork. If not, you will need to return to the Lower Leg Removal section of this manual and follow the instructions for removing your fork lowers.

## DAMPER REMOVAL/SERVICE INSTRUCTIONS

**NOTE: BoXXer ONLY, IT IS NOT NECESSARY TO REMOVE THE MOTION CONTROL ADJUSTER KNOB. PLEASE SKIP STEP 1 AND MOVE TO STEP 2.**

1. Remove external snap ring from compression adjuster knob using external snap ring pliers and remove compression adjuster knob and o-ring seal.  
**OR**  
If fork is equipped with a remote compression lockout feature, remove external snap ring from compression adjuster spool using external snap ring pliers and remove compression adjuster spool and white top cap seal.
2. Unthread compression damper top cap with a 24 mm socket wrench.
3. Remove compression damper from upper tube/crown by pulling up and twisting side to side. Once removed, clean upper tube threads with a rag.
4. With a sharp pick, remove compression damper o-rings (located at the top and bottom of the damper). Apply a few drops of suspension oil to new o-rings and re-install.
5. Remove fork from bicycle stand and pour remaining oil into pan.
6. Remove rebound damper seal head retaining ring (located inside the bottom of the right upper tube), using external snap ring pliers. Pull down and remove the rebound damper and seal head assembly from the upper tube.
7. Slide seal head off damper shaft and remove inner and outer seal head o-rings. Apply a few drops of suspension oil to new o-rings and re-install.
8. Spray isopropyl alcohol on rebound damper shaft, and clean with a rag (not pictured).
9. If damaged, replace rebound damper piston glide ring. Position upper tube base ring on top of seal head step and slide rebound damper seal head assembly onto rebound damper shaft.
10. Spray isopropyl alcohol into the upper tube. Wrap a clean rag around a dowel and clean the inside of the upper tube (not pictured).

1



OR



2



3

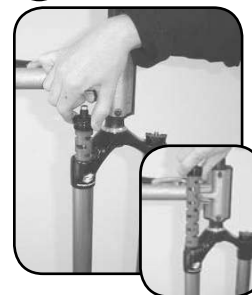

4

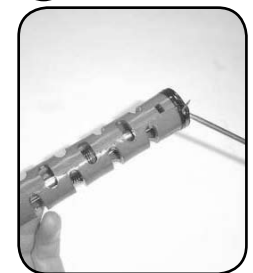

5



6



7

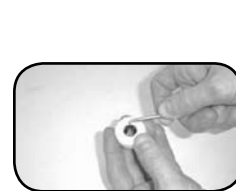

9



## OPTIONAL - COMPRESSION DAMPER UPGRADE: NON-REMOTE TO REMOTE ADJUST (EXCLUDES BOXXER)

Upgrading from a non-remote compression adjust fork to a remote compression adjust (from a crown mounted adjuster knob to a remote PopLoc or PushLoc lever adjuster), requires replacing the non-remote compression damper with a remote compression damper and cable-stop clamp. The remote return spring is designed into the compression damper and is required for use with the PopLoc and PushLoc remote lever assembly.

### DAMPER INSTALLATION INSTRUCTIONS

11. Insert rebound damper piston into the bottom of the upper tube at an angle, with the open-ended side of the glide ring face outward. Continue to angle and rotate until glide ring is in the upper tube. Position the upper tube base ring seal and seal head into the upper tube.



12. Position the upper tube base ring seal and seal head into the upper tube and press into the upper tube with your thumb.



13. Use internal snap ring pliers to secure seal head into upper tube with retaining ring.

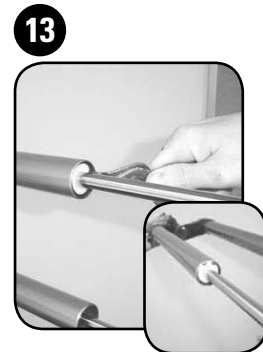

**IMPORTANT: MAKE SURE THE RETAINING RING IS SECURELY FASTENED IN THE UPPER TUBE GROOVE. YOU CAN CHECK THIS BY USING THE SNAP RING PLIERS TO ROTATE THE RETAINING RING IN THE SHAFT ONE COMPLETE REVOLUTION.**

14. Pull rebound damper shaft down, into the fully extended position. Measure and pour 5wt suspension oil into the upper tube, through the crown, using the volumes listed in the chart at right.



**\*BOXXER ONLY OPTIONAL PROCEDURE: YOU CAN USE A SUSPENSION OIL HEIGHT TOOL TO MEASURE OIL VOLUME. MEASURE AND SET SYRINGE NEEDLE STOP TO 205 MM. POUR 5WT OIL INTO UPPER TUBE. INSERT SYRINGE NEEDLE INTO THE UPPER TUBE, RESTING THE STOP FLAT ON UPPER TUBE. PULL OUT ANY EXCESS OIL WITH SYRINGE PLUNGER. REMOVE OIL HEIGHT TOOL FROM UPPER TUBE.**

**IMPORTANT: OIL VOLUME IS CRITICAL. TOO MUCH OIL REDUCES AVAILABLE TRAVEL, WHICH CAN LEAD TO FORK DAMAGE FROM COMPRESSION BOTTOM OUT. TOO LITTLE OIL DECREASES DAMPING PERFORMANCE.**

FORK	OIL VOLUME (±5cc/ML)
BOXXER RACE, TEAM, WC	150cc/ML*
PIKE 351, 409, 426, 454	120cc/ML
REBA SL, RACE, TEAM, WC	110cc/ML
RECON 351	118cc/ML
REVELATION 409, 426	114cc/ML

## DAMPER INSTALLATION INSTRUCTIONS (CONT)

15. Insert compression damper into upper tube.  
Press down and twist to work damper into upper tube.

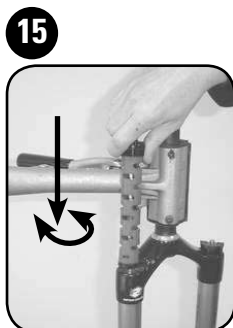

16. Turn the damper clockwise to thread into the upper tube. Be careful not to damage the upper damper o-ring. Continue to thread top cap down into upper tube threads and hand tighten. Using a 24 mm socket wrench, tighten to 60 in/lbs.



**NOTE: FOR BOXXER, THIS COMPLETES THE INSTALLATION PROCEDURES.**

**NOTE: TURN COMPRESSION ADJUSTER HEX COUNTER-CLOCKWISE TO THE OPEN POSITION.**

17. Place compression adjuster knob onto compression damper top cap with the knob dial set in the 3 o'clock position. Using external snap ring pliers, secure the compression adjuster knob with a new snap ring.



**OR**



**OR**

If fork is equipped with a remote compression lockout feature, place remote spool onto compression damper top cap with the cable set screw in the 3 o'clock position. Using external snap ring pliers, secure the remote spool with a new snap ring.

**THIS CONCLUDES THE DAMPER SERVICE FOR YOUR FORK. YOU DID A GREAT JOB! YOU ARE NOW READY TO MOVE ON TO THE NEXT SECTION: SPRING SERVICE. ENJOY!**



# MOTION CONTROL DAMPER SERVICE

(SID TEAM, WORLD CUP)

## INTRODUCTION

At this point you should already have the lowers removed from your fork. If not, you will need to return to the Lower Leg Removal section of this manual and follow the instructions for removing your fork lowers.

## DAMPER REMOVAL/SERVICE INSTRUCTIONS

1. Remove remote cable stop clamp using a 2 mm hex wrench.
2. Remove Floodgate adjuster knob using a 1.5 mm hex wrench.
3. Remove external snap ring from compression adjuster spool using external snap ring pliers and remove compression adjuster spool and return spring.
4. Unthread compression damper top cap with a 24 mm socket wrench.
5. Remove compression damper, damper tube and rebound damper assembly from upper tube/crown by pulling up and twisting side to side. Clean upper tube threads with a rag.

**NOTE: LEAVE THE THREADED BASE RETAINER INSIDE THE BOTTOM OF THE UPPER TUBE.**

6. Pull the rebound damper/seal head assembly from the bottom of the damping tube. Be sure to wrap a rag around the damper tube, as oil will drain from the assembly. Pour remaining oil from damper tube into oil pan.
7. Remove compression damper from damper tube by pulling up gently. Allow any excess oil to drain into oil pan. Pull straight out; don't twist.
8. Spray compression damper assembly and damper tube (inside and out) with isopropyl alcohol. Wipe grease and oil from damper assembly and outside of damper tube. Wrap a clean rag around a dowel and clean the inside of the damper tube (not pictured).
9. Slide seal head off rebound damper shaft and remove inner and outer seal head o-rings. Apply a few drops of suspension oil to new o-rings and install.
10. Spray rebound damper shaft with isopropyl alcohol, and clean with a rag (not pictured).
11. Inspect rebound damper piston glide ring and damper shaft. Replace either, if damaged. Slide rebound damper seal head back onto rebound damper shaft.
12. Insert a 2.5 mm hex wrench (or rebound adjuster knob) into rebound damper adjuster at the bottom of the shaft, and turn counter-clockwise to open the rebound damper valve. This allows oil to flow into the damper valve when re-filling damper tube with oil.

1



2



3



4



5



6



7



8



9



11

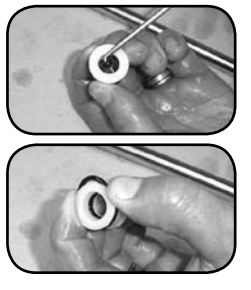

12



12



## DAMPER REMOVAL/SERVICE INSTRUCTIONS (CONT)

13. Lubricate rebound damper and seal head by submerging in a container of suspension oil.
14. Remove compression damper o-rings (lower, internal floating piston - IFP, and primary). Apply a few drops of suspension oil to new o-rings and install.

**13**



**14**



## DAMPER INSTALLATION INSTRUCTIONS

15. Place gold Floodgate adjuster knob back onto the compression damper and tighten with a 1.5 mm hex wrench.
16. Turn the compression spool adjuster hex counter-clockwise until it stops. This is the full open position.
17. Apply suspension oil to both the main piston and IFP o-rings of the compression damper.
18. Insert the compression damper back into the damper tube and slide entire damper assembly into the tube. Press top cap firmly into place.
19. Holding damper tube with the open end up, pour 5wt suspension oil into the damper tube until tube is approximately half-full. Tap the compression damper tube lightly on a flat surface to release any air bubbles trapped inside the damper.
20. Pour additional 5wt suspension oil into damper tube until completely full.
21. Remove rebound damper and seal head from the oil container in which it was submerged. Wrap a rag around the damper tube to catch displaced oil. With the seal head bottomed out, slowly insert rebound piston into the damper tube, by pushing on the seal head, until it is fully seated. Wipe all oil from damper tube.

**15**



**16**



**17**



**18**



**19**



**18**

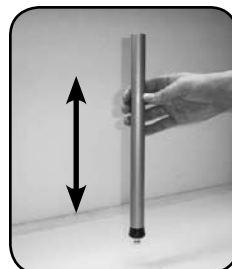

**20**



**21**



**21**



**IMPORTANT: DO NOT CYCLE THE REBOUND DAMPER INTO THE DAMPER TUBE. THE COMPRESSION DAMPER IS NOT SECURE IN THE DAMPER TUBE UNTIL THREADED INTO THE UPPER AND TIGHTENED WITH A SOCKET WRENCH.**

## DAMPER INSTALLATION INSTRUCTIONS (CONT)

22. Inside the damper upper tube is an o-ring that sits between the damper tube/rebound seal head assembly and the upper tube thread base retainer. Ensure the o-ring is positioned flat on the threaded upper tube base retainer. If the o-ring came out with the damper tube assembly, apply a small amount of grease to the o-ring and re-position it on the bottom of the rebound damper seal head.
23. Insert the damper assembly back into the upper tube, rebound shaft first. Guide the end of the rebound damper through the center of the threaded base retainer, sliding the damper completely into the upper tube.
24. Hand thread the compression damper top cap into the upper tube. Use a 24 mm socket wrench and tighten top cap to 60 in-lb.  
**IMPORTANT: DO NOT ALLOW REBOUND DAMPER SHAFT TO SCRAPE THE RETAINER UPON INSERTION.**
25. Insert the rebound damper external adjuster knob into the bottom of the rebound damper shaft and turn clockwise until damper is in the full closed position. This will protect the damper rod when installing the lower leg shaft bolt.

22



23



24



25



## OPTIONAL - REMOTE ADJUST TO NON-REMOTE

Switching from a remote compression adjust to a crown mounted compression adjust requires only the removal of the remote spool and cable stop clamp assemblies, and installation of the standard compression adjuster knob. Unlike standard Motion Control compression dampers, the 07 SID Motion Control compression damper remote return spring is NOT integrated into the damper assembly. The remote PopLoc or PushLoc lever adjuster can either be removed from the handlebar, or simply remove the cable/cable housing and leave the PopLoc or PushLoc lever on your handlebar, in case you choose to re-install the remote spool in the future.

## DAMPER INSTALLATION INSTRUCTIONS (CONT)

26. Remove Floodgate adjuster knob again, using a 1.5 mm hex wrench (not pictured)
27. Place cable stop clamp onto the top cap with the cable stop positioned at approximately 90° forward from the steerer tube. Turn the compression spool adjuster shaft (hex shaped) counter-clockwise until it stops, to ensure it is in the open (unlocked) position.
28. Place the remote spool onto the compression spool adjuster shaft and turn clockwise until it stops, in the closed (lockout) position. Hold the remote spool in the closed position and use your free hand to rotate the cable stop clamp counter-clockwise until it touches the remote spool stop.
29. Tighten cable stop clamp with a 2.5 mm hex wrench. Check the position of the remote spool by rotating it counter-clockwise to the full open (unlocked) position. The set screw should be in line with the open mark on the cable stop clamp.

27



28



29

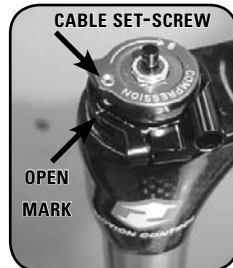

## DAMPER INSTALLATION INSTRUCTIONS (CONT)

30. Remove the remote spool while the compression adjuster is in the open (unlock) position. Apply a small amount of grease to the remote spool return spring (grease will hold the return spring in the remote spool during installation). Insert the return spring into the underside of the remote spool, with the long spring leg facing out.
31. Place the remote spool and return spring onto the compression damper adjuster hex by aligning the long leg of the return spring to fit into one detent hole in the top cap, at the same time as aligning the cable set screw with the open mark on the cable stop clamp.
32. Turn the remote spool clockwise until spool-stop rests in the closed position against the cable stop clamp stop. If the stop on the remote spool does not touch the stop on the cable stop clamp, loosen cable stop clamp and rotate it counter-clockwise until the two stops touch and retighten cable stop clamp. Release the spool from the close position and test the return to the open position.
33. Using external snap ring pliers, secure the remote spool with a new snap ring.
34. Place the Floodgate adjuster knob back onto the compression damper spool shaft. Tighten the Floodgate adjuster knob set screw to the flat surface of the black adjuster rod with a 1.5 mm hex wrench.

30



31



32



33



34



**THIS CONCLUDES THE DAMPER SERVICE FOR YOUR FORK. YOU DID A GREAT JOB! YOU ARE NOW READY TO MOVE ON TO THE NEXT SECTION: SPRING SERVICE. ENJOY!**

# PURE DELITE DAMPER SERVICE

(SID RACE)

## INTRODUCTION

At this point you should already have the lowers removed from your fork. If not, you will need to return to the Lower Leg Removal section of this manual and follow the instructions for removing your fork lowers.

## DAMPER REMOVAL/SERVICE INSTRUCTIONS

**IMPORTANT: VERIFY ALL AIR PRESSURE IS REMOVED FROM THE PURE DELITE AIR CHAMBER BEFORE PROCEEDING. REMOVE AIR VALVE COVER CAP AND DEPRESS SCHRADER VALVE TO RELEASE ANY AIR PRESSURE.**

1. Unthread compression damper top cap with a 24 mm socket wrench.
2. Pull up and remove the entire Pure Delite damper assembly from the upper tube. Remove the top cap by pulling out of the Pure Delite damper tube.
3. Invert the damper assembly and gently, but firmly, pull the rebound damper seal head assembly from the Pure tube. Hold a rag around tube while pulling, to catch any oil that may spill. Pour any remaining oil from the Pure tube into oil pan.
4. Remove the Internal Floating Piston (IFP), which is located inside the Pure damper tube, in the center of the tube. The IFP is the seal that separates the oil from the air in the Delite air chamber. To remove the IFP, insert a long dowel rod (plastic or wood) into the Pure tube until the rod touches the underside of the IFP. Push firmly on the rod to release the IFP from the Pure tube.

**IMPORTANT: BE CAREFUL NOT TO SCRATCH THE INSIDE OF THE PURE TUBE WITH THE DOWEL ROD. SCRATCHES WILL CAUSE OIL/AIR TO LEAK AND THE PURE DELITE DAMPER SYSTEM WILL NOT FUNCTION PROPERLY.**

5. Review the Pure Delite Damper assembly components.
6. Remove IFP inner and outer o-rings. Apply a few drops of suspension oil to new o-ring and re-install (not pictured).
7. Slide seal head off rebound damper shaft and remove inner and outer seal head o-rings. Apply a few drops of suspension oil to new o-rings and re-install. Inspect damper shaft for scratches and replace if damaged. Place seal head back onto rebound damper shaft.

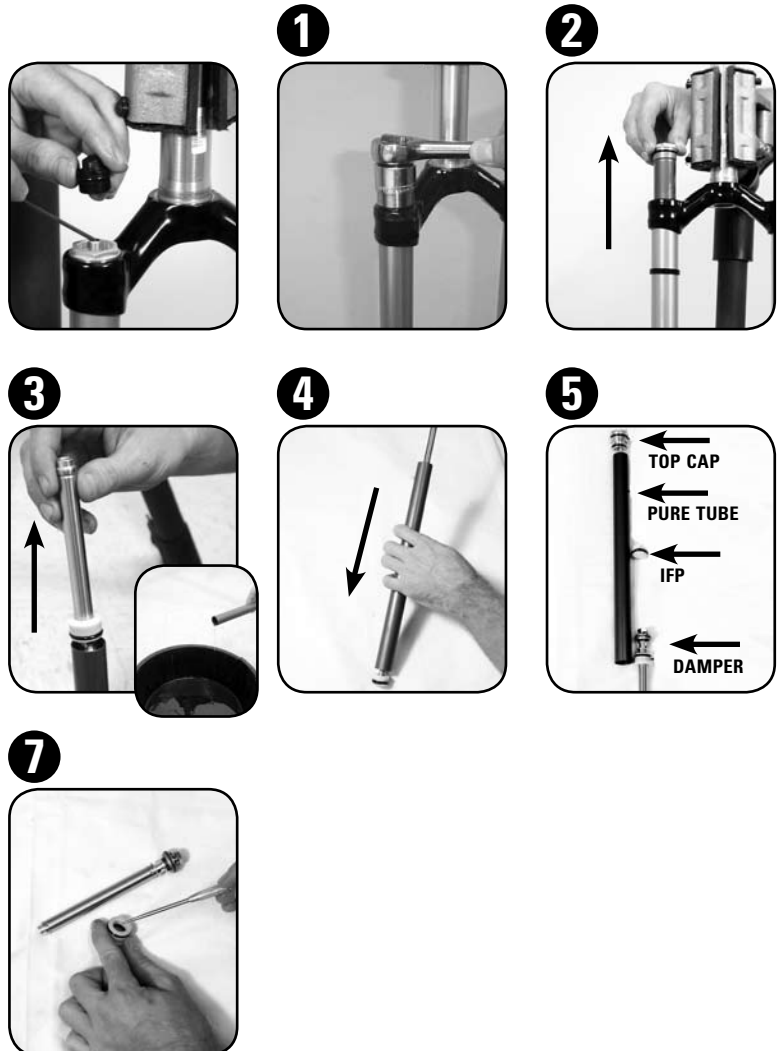

## DAMPER INSTALLATION INSTRUCTIONS

9. Insert IFP in the Pure tube at a depth of 6 inches. To do this, mount a long dowel rod (plastic or wood) into a bicycle stand clamp or bench vise with 6 inches of exposed rod. Place the IFP on the end of the dowel, pocketed side down. Place one end of the Pure Tube over the IFP and press firmly down until the IFP is seated inside the tube.

**NOTE: BE CAREFUL NOT TO DAMAGE IFP O-RING OR YOUR HANDS ON THE SHARP EDGES OF THE PURE TUBE. USE A RAG TO PROTECT YOUR HANDS.**

9

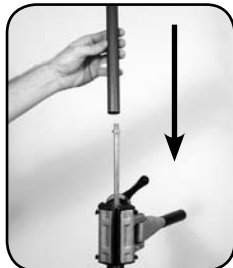

10



10. Continue to press the IFP into the Pure tube until the tube end is flush against the bicycle clamp or vise. The IFP is now seated firmly inside the Pure tube at a 6 inch depth. Pull the Pure tube off the dowel.

11



12

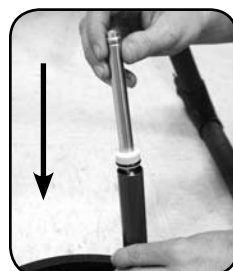

13

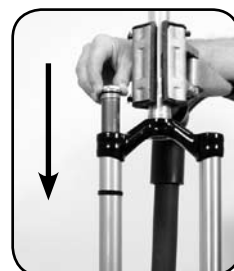

11. Hold the Pure tube over oil pan, with the pocketed side of the IFP facing down (rounded side facing up) and fill the tube completely with 15wt suspension oil.

12. Make sure the rebound damper is in the open position.

**NOTE: BE SURE PISTON SEAL HEAD IS TOPPED AGAINST REBOUND PISTON.**

Gently and slowly insert the rebound damper piston head into the oil filled Pure tube. The oil will slowly fill the damper valves (some oil will spill). Allow enough oil to fill the damper valve cavities and top off oil volume if necessary. With the seal head bottomed out, gently press down on the seal head until it snaps into the Pure tube securely. Your damper is now sealed.

**IMPORTANT: DO NOT CYCLE THE DAMPER SHAFT UNTIL THE DELITE AIR TOP CAP HAS BEEN INSTALLED AND PRESSURIZED.**

14



15



16



13. Insert the Pure Delite damper assembly into the upper tube through the crown.

14. Add 6cc/ml of 15wt suspension oil to the top chamber of the damper. This will lubricate the IFP o-ring.

15. Hand thread the damper top cap into the upper tube. Use a 24 mm socket wrench and tighten top cap to 60 in-lb. Pressurize the air chamber with your shock pump to 20-60psi. The IFP is now pressure set and your damper sealed.

16. Insert the rebound damper external adjuster knob into the bottom of the rebound damper shaft and turn clockwise until damper is in the full closed position. This will protect the damper rod when installing the lower leg shaft bolt.

**THIS CONCLUDES THE DAMPER SERVICE FOR YOUR FORK. YOU DID A GREAT JOB! YOU ARE NOW READY TO MOVE ON TO THE NEXT SECTION: SPRING SERVICE. ENJOY!**

# MISSION CONTROL DAMPER SERVICE

## (LYRIK - TOTEM)

### INTRODUCTION

At this point you should already have the lowers removed from your fork. If not, you will need to return to the Lower Leg Removal section of this manual and follow the instructions for removing your fork lowers.

### DAMPER REMOVAL/SERVICE INSTRUCTIONS

1. Turn blue high speed compression knob clockwise, to set in the maximum compression position. (not pictured)
2. Turn Floodgate to "off" position by pushing low speed compression adjuster down and rotating counter-clockwise 90°.
3. Unthread compression damper top cap with a thin 24 mm wrench. Access to the top cap is under the high speed compression knob.

**2**



**3**



OR

OR

Insert a 2.5 mm hex wrench into the gold low speed compression knob and turn it counter-clockwise until it stops (not pictured). This allows maximum insertion depth for the 4 mm wrench. Gently grasp the low speed compression knob with the slip joint pliers, using a 4 mm hex wrench to remove low speed compression screw. Lift and remove the low speed compression knob. Then, using a 1.5 mm hex wrench, loosen both retaining bolts on the high speed compression knob. Remove the high speed compression knob. This allows access to the top cap. Unthread compression damper top cap using a 24 mm socket wrench.



4. Remove compression damper from upper tube/crown by pulling up and twisting side to side. Once removed, clean upper tube threads with a rag.
5. Remove glide ring from compression damper piston assembly. Apply a few drops of suspension oil to new glide ring and re-install.
6. Remove fork from bicycle stand and pour remaining oil into pan. Return fork to bicycle stand.
7. Remove rebound damper seal head retaining ring (located inside the bottom of the right upper tube), using internal snap ring pliers. Pull down and remove the rebound damper assembly from the upper tube.
8. Push upward on rebound shaft to separate rebound piston assembly from rebound tube.
9. Spray rebound damper shaft with isopropyl alcohol, and clean with a rag (not pictured).

**4**



**5**



**6**



**7**



**8**

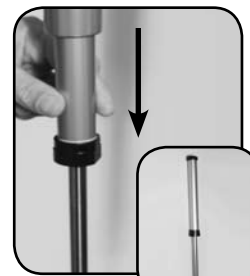

**8**



## DAMPER REMOVAL/SERVICE INSTRUCTIONS (CONT)

10. Remove inner and outer o-rings from rebound seal head. Apply a few drops of suspension oil to new o-rings and re-install.

**IMPORTANT: IF USING A PICK TO REMOVE INNER SEAL HEAD O-RING, DO NOT SCRATCH O-RING GLAND. SCRATCHES MAY CAUSE OIL TO LEAK.**

11. Remove glide ring from rebound shaft assembly. Apply a few drops of suspension oil to new glide ring and re-install.



## DAMPER INSTALLATION INSTRUCTIONS

12. Install rebound shaft assembly into rebound tube.

**NOTE: BE SURE NOT TO DAMAGE REBOUND TUBE INNER O-RING.**

13. Install rebound assembly into upper tube and secure with retaining ring using internal snap ring pliers.

**IMPORTANT: MAKE SURE THE RETAINING RING IS SECURELY FASTENED IN THE UPPER TUBE GROOVE. YOU CAN CHECK THIS BY USING THE SNAP RING PLIERS TO ROTATE THE RETAINING RING IN THE SHAFT ONE COMPLETE REVOLUTION.**

14. Pull rebound damper shaft down into the fully extended position.  
15. Measure and pour 5wt suspension oil into the upper tube, through the crown, using the following volumes:

FORK	OIL VOLUME (±3CC/ML)
LYRIK	112cc/ML
TOTEM	137cc/ML

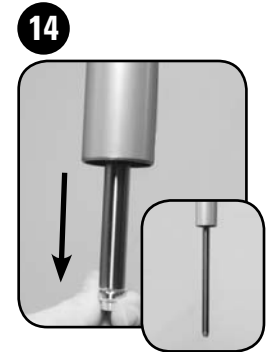
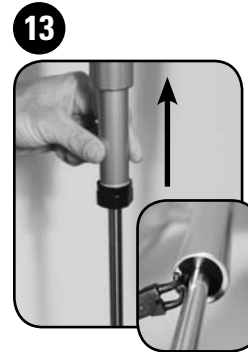
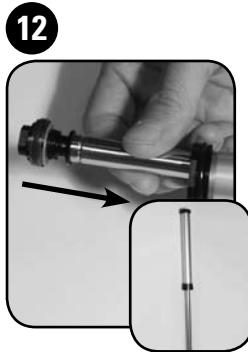

**IMPORTANT: OIL VOLUME IS CRITICAL. TOO MUCH OIL REDUCES AVAILABLE TRAVEL, WHICH CAN LEAD TO FORK DAMAGE FROM COMPRESSION BOTTOM OUT. TOO LITTLE OIL DECREASES DAMPING PERFORMANCE.**



## DAMPER INSTALLATION INSTRUCTIONS (CONT)

16. Double check the Floodgate to ensure it is in the "off" position. Install Mission Control damper assembly into upper tube through the crown. Hand thread the compression damper top cap into the upper tube. Use a thin 24 mm socket wrench and tighten top cap to 60 in-lb.

OR

Double check the Floodgate to ensure it is in the "off" position. Insert Mission Control damper assembly into upper tube through the crown. Hand thread the compression damper top into the upper tube. Use a 24 mm socket wrench and tighten top cap to 60 in-lb. Install high speed compression knob using a 1.5 mm hex wrench to tighten screws. Install low speed compression knob by gently grasping the knob with slip joint pliers and using a 4 mm hex wrench to tighten screw.

**THIS CONCLUDES THE DAMPER SERVICE FOR YOUR FORK. YOU DID A GREAT JOB! YOU ARE NOW READY TO MOVE ON TO THE NEXT SECTION: SPRING SERVICE. ENJOY!**

16

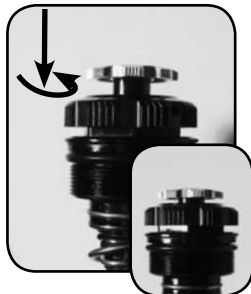

OR





# SPRING SERVICE

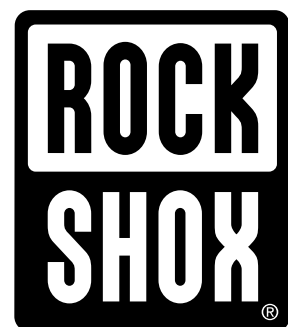

# COIL SPRING SERVICE

(ARGYLE 302, 318 - DART 1, 2, 2 (WITH TURNKEY), 3 - DOMAIN 302, 318 - TORA 289, 302, 318)

## INTRODUCTION

At this point you should already have the lowers removed from your fork. If not, you will need to return to the Lower Leg Removal section of this manual and follow the instructions for removing your fork lowers.

## COIL SPRING REMOVAL/SERVICE INSTRUCTIONS

1. Unthread and remove spring top cap with a 24 mm socket wrench.  
**IMPORTANT: PRESS DOWN FIRMLY WHEN LOOSENING TOP CAP.**
2. Argyle 302, 318 Only: Remove spring pre-load spacer(s).
3. Push spring shaft upward, from the bottom of the upper tube, then remove spring and spring spacers from upper tube.
4. Turn fork upside down and slide the spring shaft assembly out of the upper tube. Remove spring shaft assembly and inspect for damage.
5. Spray isopropyl alcohol on spring, spring shaft assembly and the inside and outside of the upper tube and wipe with a clean rag. Wrap a clean rag around a long dowel and insert into the upper tube to clean inside the upper tube (not pictured).

1



2



3

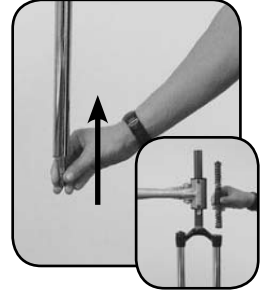

4

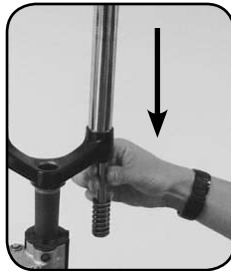

## COIL SPRING INSTALLATION INSTRUCTIONS

5. Insert and drop spring shaft assembly into upper tube through the crown. Guide the threaded end through the shaft guide at the bottom of the upper tube and gently pull shaft through to full extension.
6. Apply fresh grease liberally to spring/spring spacer assembly.
7. Insert and drop spring assembly into upper tube through the crown.
8. Argyle 302, 318 Only: Install spring pre-load spacers.
9. Clean top cap, then apply a small amount of grease to top cap threads. Insert top cap into upper tube/crown and hand thread into upper tube. Using a 24 mm socket wrench, tighten to 60 in-lb.

5

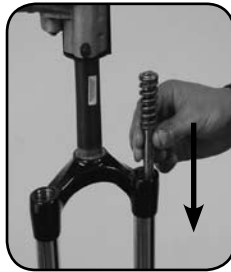

6



7

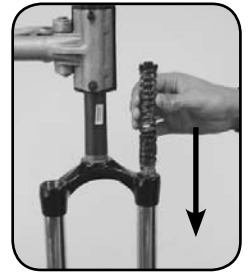

8



9



**THIS CONCLUDES THE SPRING SERVICE FOR YOUR FORK. YOU DID A GREAT JOB! YOU ARE NOW READY TO MOVE ON TO THE NEXT SECTION: LOWER LEG INSTALLATION. ENJOY!**

# COIL SPRING SERVICE

(BOXXER RACE, TEAM - RECON 335, 351, RACE, SL - TOTEM)

## INTRODUCTION

At this point you should already have the lowers removed from your fork. If not, you will need to return to the Lower Leg Removal section of this manual and follow the instructions for removing your fork lowers.

## SPRING REMOVAL/SERVICE INSTRUCTIONS

1. Unthread and remove spring top cap with a 24 mm socket wrench.  
**IMPORTANT: PRESS DOWN FIRMLY WHEN LOOSENING TOP CAP.**
2. Remove spring pre-load spacer(s) and pull spring from upper tube.
3. Remove the spring shaft base plate retaining ring using internal snap ring pliers.
4. Pull spring shaft and base plate from upper tube. Inspect assembly for damage and replace entire assembly if necessary.
5. Spray isopropyl alcohol on spring, spring isolators (isolators are BoXXer only), spring shaft and the inside and outside of the upper tube and wipe with a clean rag. Wrap a clean rag around a long dowel and insert into the upper tube to clean inside the upper tube (not pictured).  
**NOTE: YOU CAN SECURE THE SPRING ISOLATORS TO THE SPRING (BoXXer ONLY) BY USING A HEAT GUN OR HAIR DRYER TO SHRINK THEM AROUND THE SPRING.**

1



2

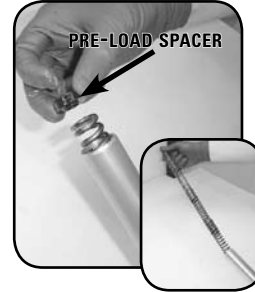

3



4

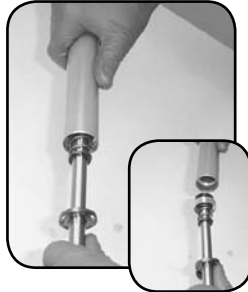

## COIL SPRING INSTALLATION INSTRUCTIONS

6. Insert spring shaft assembly back into bottom of upper tube so the base plate assembly is seated into the upper tube step. Secure spring shaft assembly with retaining ring, using internal snap ring pliers.
7. Apply fresh grease liberally to spring and spring isolators (isolators are BoXXer only).
8. Insert spring back into upper tube and place spring preload spacer(s) on top of spring inside upper tube.
9. Clean top cap, then apply a small amount of grease to top cap threads. Insert top cap into upper tube/crown and hand thread into upper tube. Using a 24 mm socket wrench, tighten to 60 in-lb.

6

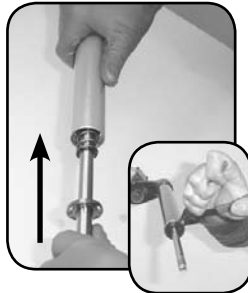

7



8



9

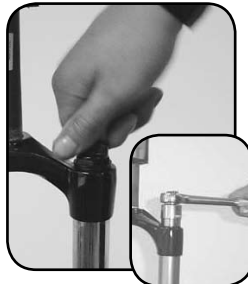

**THIS CONCLUDES THE SPRING SERVICE FOR YOUR FORK. YOU DID A GREAT JOB! YOU ARE NOW READY TO MOVE ON TO THE NEXT SECTION: LOWER LEG INSTALLATION. ENJOY!**

# COIL U-TURN SPRING SERVICE

(DOMAIN 302, 318 - TORA 289, 302, 318)

## INTRODUCTION

At this point you should already have the lowers removed from your fork. If not, you will need to return to the Lower Leg Removal section of this manual and follow the instructions for removing your fork lowers.

## COIL U-TURN SPRING REMOVAL/SERVICE INSTRUCTIONS

1. Remove U-Turn knob screw with a 2.5 mm hex wrench and remove U-Turn adjuster knob.
2. Remove detent ball bearings and detent springs from top cap using a magnet.
3. Unthread and remove spring top cap with a 24 mm socket wrench. The spring is attached to the top cap and spring shaft. Pull and lift entire spring assembly from upper tube.

**IMPORTANT: PRESS DOWN FIRMLY WHEN LOOSENING TOP CAP.**

4. Remove U-Turn negative spring assembly from upper tube, you may need to turn fork upside down to remove.
5. Spray isopropyl alcohol on entire spring assembly, negative spring, and the inside and outside of the upper tube and wipe with a clean rag. Wrap a clean rag around a long dowel and insert into the upper tube to clean inside the upper tube (not pictured).

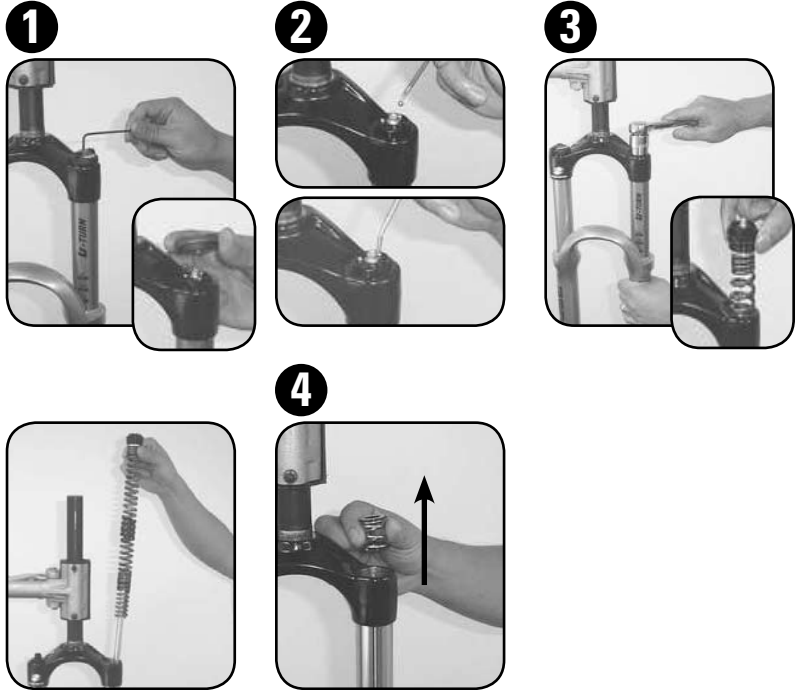

## COIL U-TURN SPRING INSTALLATION INSTRUCTIONS

6. Apply fresh grease liberally to negative spring, the entire spring assembly, and top cap threads.
7. Insert and drop negative spring into upper tube through the crown.
8. Insert U-Turn spring assembly into upper tube through crown, shaft end first. Align and seat the spring shaft through the shaft guide/base plate.
9. Insert top cap into upper tube/crown and hand thread into upper tube. Using a 24 mm socket wrench, tighten to 60 in-lb.
10. Using a magnet, insert each detent spring into top cap detent holes, evenly spaced. Place each detent ball bearing on top of each detent spring.
11. Place U-Turn adjuster knob on top of hex. Tighten U-Turn knob screw with a 2.5 mm hex wrench.

**THIS CONCLUDES THE SPRING SERVICE FOR YOUR FORK. YOU DID A GREAT JOB! YOU ARE NOW READY TO MOVE ON TO THE NEXT SECTION: LOWER LEG INSTALLATION. ENJOY!**

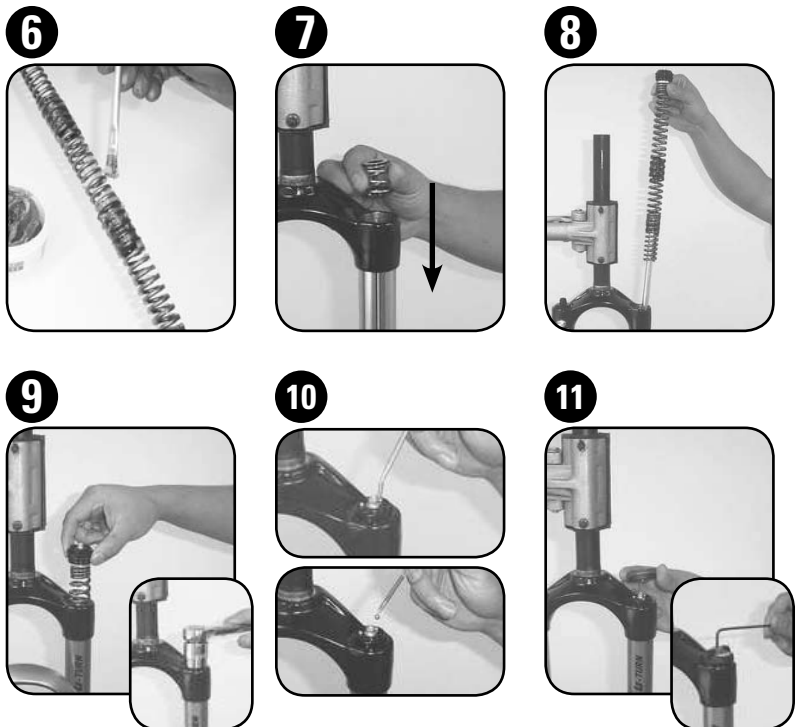

# COIL U-TURN SPRING SERVICE

(LYRIK - PIKE 327, 351, 409, 426, 454 - RECON 351, RACE - REVELATION 426)

## INTRODUCTION

At this point you should already have the lowers removed from your fork. If not, you will need to return to the Lower Leg Removal section of this manual and follow the instructions for removing your fork lowers.

## COIL U-TURN SPRING REMOVAL/SERVICE INSTRUCTIONS

1. Remove U-Turn knob screw with a 2.5 mm hex wrench and remove U-Turn adjuster knob.
2. Remove detent ball bearings and detent springs from top cap using a magnet.
3. Unthread and remove spring top cap with a 24 mm socket wrench. The spring is attached to the top cap and spring shaft. Pull and lift entire spring assembly from upper tube.

**IMPORTANT: PRESS DOWN FIRMLY WHEN LOOSENING TOP CAP.**

4. Spray isopropyl alcohol on entire spring assembly and the inside and outside of the upper tube and wipe with a clean rag. Wrap a clean rag around a long dowel and insert into the upper tube to clean inside the upper tube (not pictured).

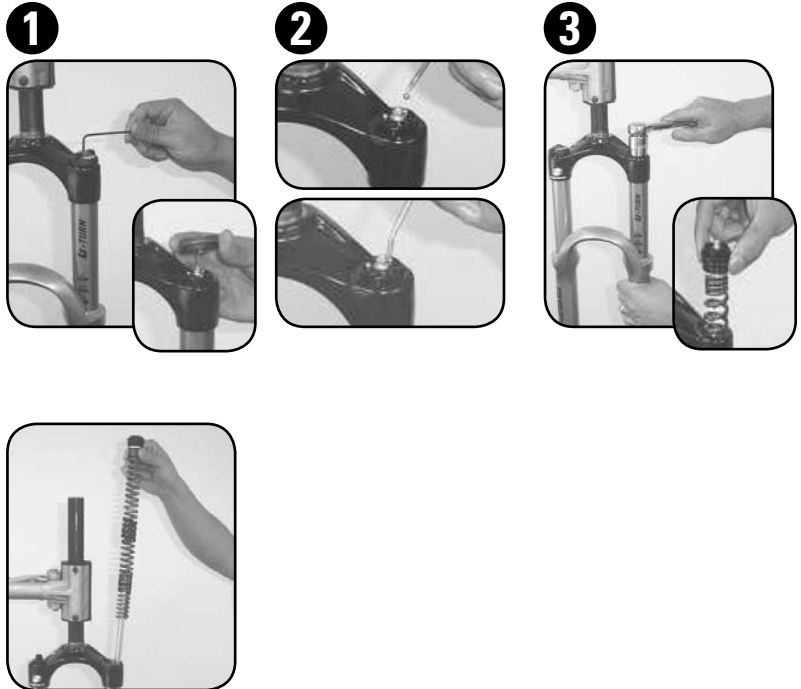

## COIL U-TURN SPRING INSTALLATION INSTRUCTIONS

5. Apply fresh grease liberally to the entire spring assembly, and top cap threads.
6. Insert U-Turn spring assembly into upper tube through crown, shaft end first. Align and seat the spring shaft through the shaft guide/base plate.
7. Insert top cap into upper tube/crown and hand thread into upper tube. Using a 24 mm socket wrench, tighten to 60 in-lb.
8. Using a magnet, insert each detent spring into top cap detent holes, evenly spaced. Place each detent ball bearing on top of each detent spring.
9. Place U-Turn adjuster knob on top of hex. Tighten U-Turn knob screw with a 2.5 mm hex wrench.

**THIS CONCLUDES THE SPRING SERVICE FOR YOUR FORK. YOU DID A GREAT JOB! YOU ARE NOW READY TO MOVE ON TO THE NEXT SECTION: LOWER LEG INSTALLATION. ENJOY!**

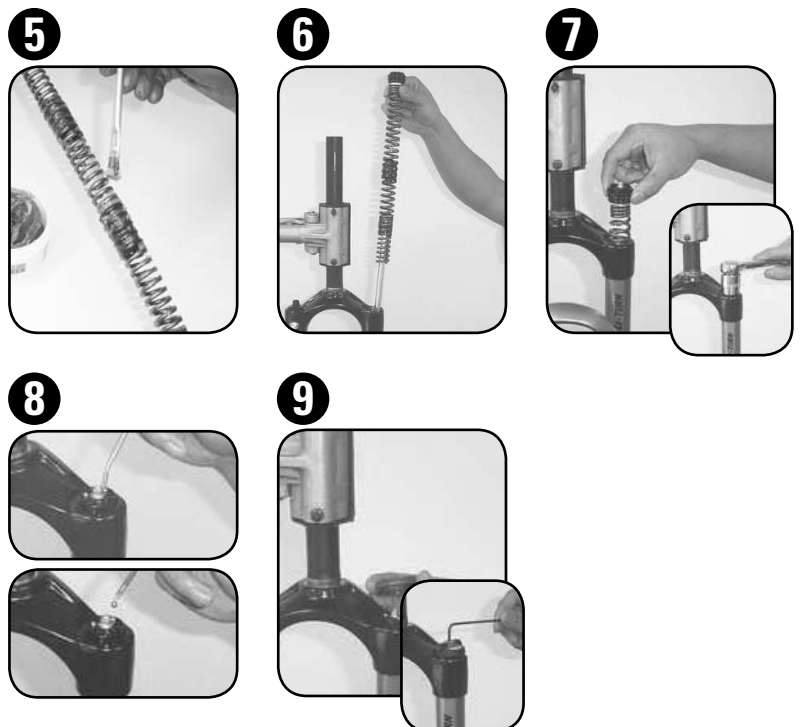

# SOLO AIR SPRING SERVICE

(ARGYLE 409 - TORA 302, 318)

## INTRODUCTION

At this point you should already have the lowers removed from your fork. If not, you will need to return to the Lower Leg Removal section of this manual and follow the instructions for removing your fork lowers.

## SOLO AIR SPRING REMOVAL/SERVICE INSTRUCTIONS

**IMPORTANT: VERIFY ALL AIR PRESSURE IS REMOVED FROM THE AIR CHAMBER BEFORE PROCEEDING. DEPRESS SCHRADER VALVE AGAIN TO REMOVE ANY REMAINING AIR PRESSURE.**

1. Unthread air spring top cap with a 24 mm socket wrench. The air spring assembly is attached to the top cap. Pull and lift entire air spring assembly from upper tube.
2. Pull top cap out of air tube assembly and pour any air seal lubricant into oil pan.
3. Remove air shaft and air seal head from the bottom of the air tube by pulling shaft down and twisting side to side.
4. Spray isopropyl alcohol on the inside and outside of the upper tube and wipe with a clean rag. Wrap a clean rag around a long dowel and insert into the upper tube to clean inside the upper tube (not pictured).
5. Remove air piston retainer ring using external snap ring pliers. Then remove air piston wavy spring washer and piston from air shaft.
6. Slide air sleeve seal head assembly from air shaft.
7. Remove inner and outer seal head o-rings. Apply a few drops of suspension oil to new o-rings and re-install.

**IMPORTANT: IF USING A PICK TO REMOVE O-RINGS, DO NOT SCRATCH SEAL HEAD. SCRATCHES MAY CAUSE OIL TO LEAK.**

8. Spray air shaft with isopropyl alcohol and wipe clean with a rag (not pictured).
9. Insert air piston back onto air shaft head. Install spring wavy washer onto air shaft end and secure in place with air piston retainer ring, using external snap ring pliers. Check retaining ring fit to make sure it secures the air piston to air shaft head. The piston should compress slightly with spring resistance against wavy spring washer and retaining ring.

1



2



3



5



6

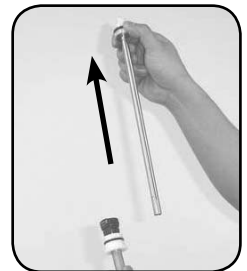

7



9





## SOLO AIR SPRING REMOVAL/SERVICE INSTRUCTIONS (CONT)

10. Remove bottom-out bumper and kick plate from negative air sleeve/seal head.
11. Remove inner and outer seal head o-rings. Apply a few drops of suspension oil to new o-rings and re-install.

**IMPORTANT: IF USING A PICK TO REMOVE O-RINGS, DO NOT SCRATCH SEAL HEAD. SCRATCHES MAY CAUSE OIL TO LEAK.**

10



11



## OPTIONAL - ALL TRAVEL CONFIGURATIONS (TORA 318)

All travel spacers are located just above the air seal head. If you want to change the travel of your fork, snap the travel spacer onto seal head to decrease travel, or remove to increase travel.

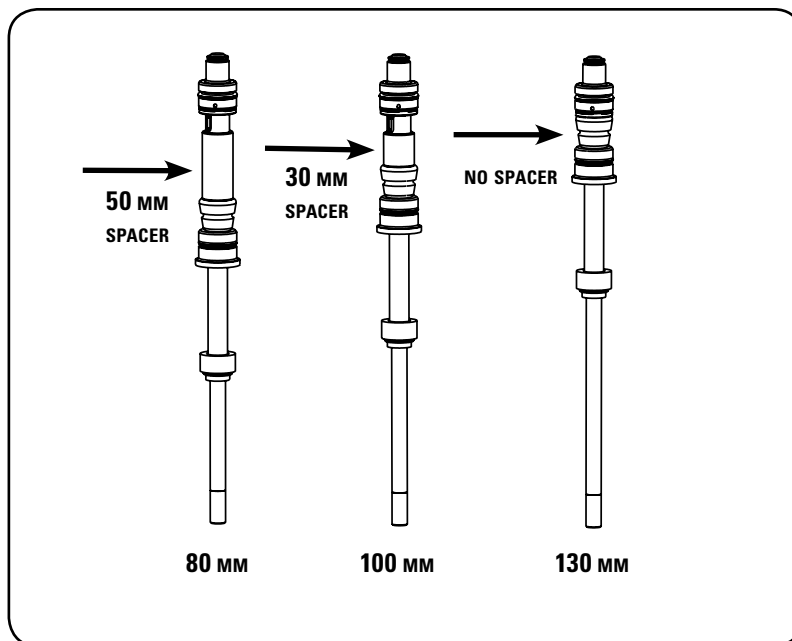

## SOLO AIR SPRING INSTALLATION INSTRUCTIONS

12. Insert bottom-out bumper and pad back onto air seal head. Slide air seal head/sleeve assembly back into air shaft, bumpers first.
13. Insert lubricated air assembly, both pistons and air sleeve into one end of air tube. Push air seal head into air tube until firmly seated.
14. Insert air shaft into top of upper tube, through crown. Guide the bottom of the air shaft through the shaft guide in the bottom of the upper tube. Insert air tube assembly into upper tube until it rests inside upper tube.
15. Measure and pour 6cc/ml of 15wt suspension oil into upper tube through the crown. Suspension oil in the air chamber lubricates the air seal o-ring during use and maintains the air seal.
16. Push air shaft to lift air tube out of upper tube a couple of inches. Insert the air top cap into air tube and press tight into air tube.
17. Drop air tube/top cap assembly into upper tube. Check bottom of upper tube and make sure air shaft guide is seated into upper tube shaft guide.
18. Insert top cap into upper tube/crown and hand thread into upper tube. Using a 24 mm socket wrench, tighten to 60 in-lb.

12



13



14

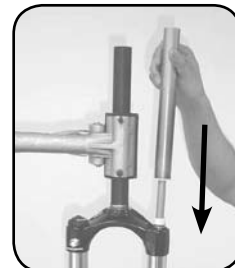

15



16

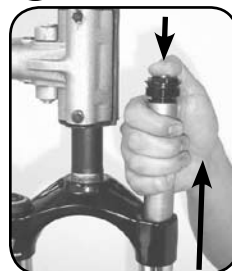

17

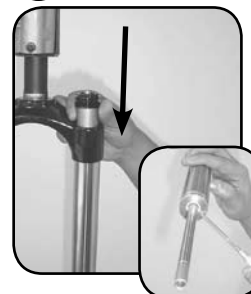

18



**THIS CONCLUDES THE SPRING SERVICE FOR YOUR FORK. YOU DID A GREAT JOB! YOU ARE NOW READY TO MOVE ON TO THE NEXT SECTION: LOWER LEG INSTALLATION. ENJOY!**

# SOLO AIR SPRING SERVICE

(BOXXER WC - LYRIK - RECON - TOTEM)

## INTRODUCTION

At this point you should already have the lowers removed from your fork. If not, you will need to return to the Lower Leg Removal section of this manual and follow the instructions for removing your fork lowers.

## SOLO AIR SPRING REMOVAL/SERVICE INSTRUCTIONS

**IMPORTANT: VERIFY ALL AIR PRESSURE IS REMOVED FROM THE AIR CHAMBER BEFORE PROCEEDING. DEPRESS SCHRADER VALVE AGAIN TO REMOVE ANY REMAINING AIR PRESSURE.**

1. Unthread and remove air spring top cap with a 24 mm socket wrench. Remove fork from stand and pour any air seal lubricant into oil pan.
2. Use your finger to press the air seal head into the upper tube. You will feel it break free and slide into the tube about 3 mm.
3. Remove the air assembly shaft guide retaining ring from the bottom of the left upper tube, using external snap ring pliers. Pull air shaft down to remove air spring assembly and shaft guide from upper tube.
4. Spray isopropyl alcohol on the inside and outside of the upper tube and wipe with a clean rag. Wrap a clean rag around a long dowel and insert into the upper tube to clean inside the upper tube (not pictured).

**NOTE: FOR LYRIK, AND TOTEM IT IS NOT NECESSARY TO PERFORM STEPS 5, 6, 7 OR 9. SIMPLY INSPECT RETAINER RING AND WAVY WASHER (AND CUSHION ON LYRIK AND TOTEM). IF DAMAGED, YOU WILL NEED TO REPLACE THE AIR PISTON HEAD ASSEMBLY. OTHERWISE PLEASE COMPLETE STEP 8, THEN MOVE TO STEP 11.**

5. Remove air piston retainer ring using external snap ring pliers. Then remove air piston wavy spring washer and piston from air shaft.
6. Slide air sleeve/seal head assembly from air shaft.
7. Remove inner and outer seal head o-rings. Apply a few drops of suspension oil to new o-rings and re-install.

**IMPORTANT: IF USING A PICK TO REMOVE O-RINGS, DO NOT SCRATCH SEAL HEAD. SCRATCHES MAY CAUSE OIL TO LEAK.**

8. Spray air shaft with isopropyl alcohol and wipe clean with a rag (not pictured).

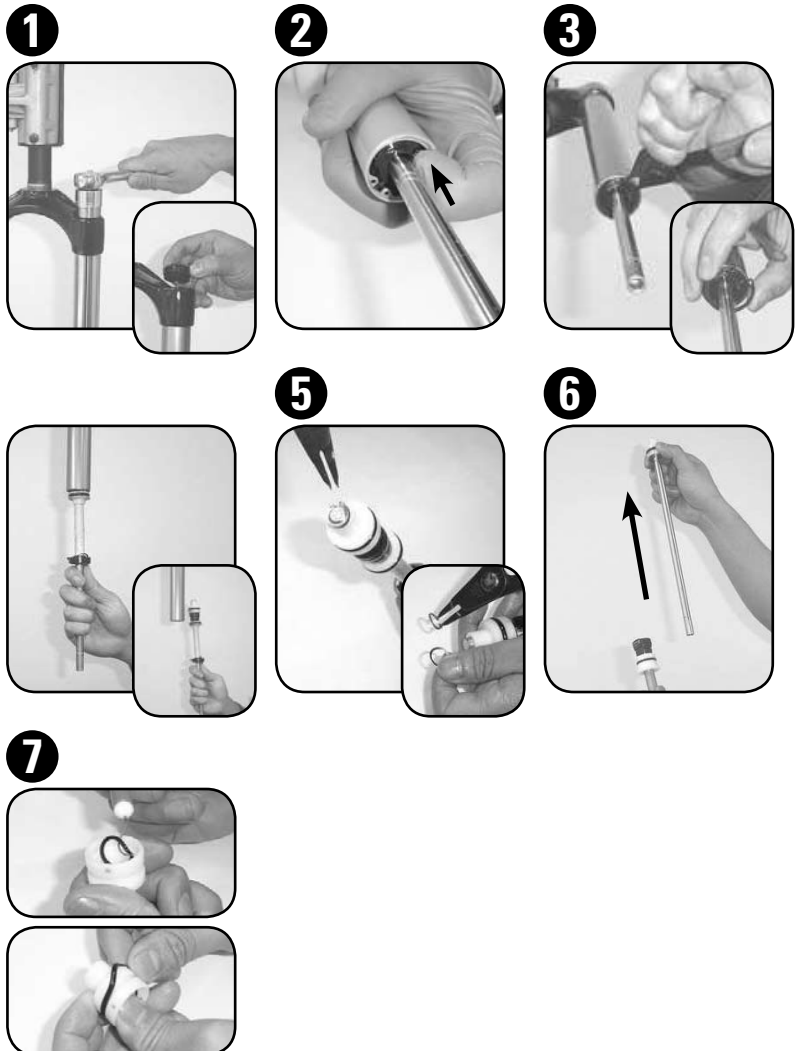

## SOLO AIR SPRING REMOVAL/SERVICE INSTRUCTIONS (CONT)

9. Insert air piston back onto air shaft head. Install spring wavy washer on air shaft end and secure in place with air piston retainer ring, using external snap ring pliers. Check retaining ring fit to make sure it secures the air piston to air shaft head. The piston should compress slightly with spring resistance against wavy spring washer and retaining ring.
10. Remove bottom-out bumper and kick plate from negative air sleeve/seal head.
11. Remove inner and outer seal head o-rings. Apply a few drops of suspension oil to new o-rings and re-install.

**IMPORTANT: IF USING A PICK TO REMOVE O-RINGS, DO NOT SCRATCH SEAL HEAD. SCRATCHES MAY CAUSE OIL TO LEAK.**

9



10



11



## OPTIONAL - ALL TRAVEL CONFIGURATIONS (RECON 327, 335, 351)

All travel spacers are located just above the air seal head. If you want to change the travel of your fork, snap the travel spacer onto seal head to decrease travel, or remove to increase travel.

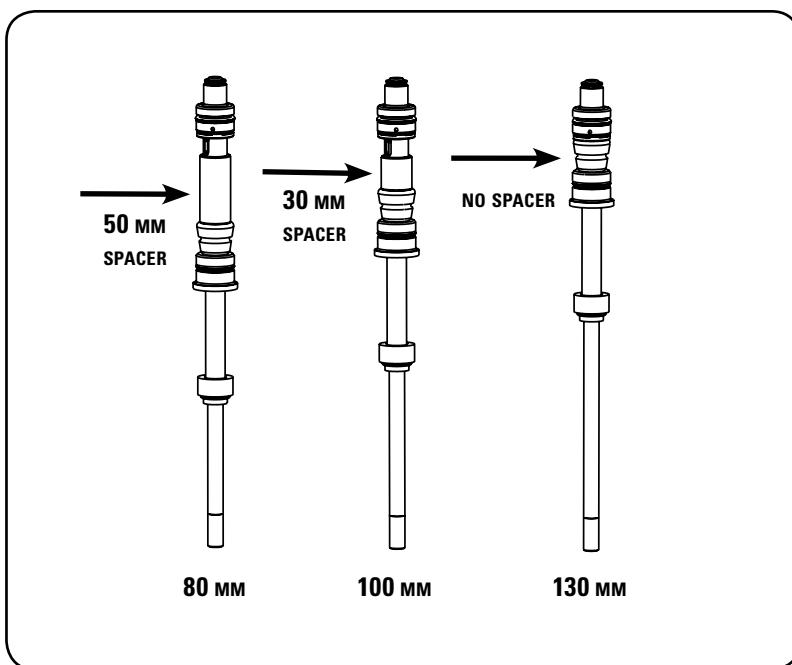

## SOLO AIR SPRING INSTALLATION INSTRUCTIONS

12. Insert bottom-out bumper and kick plate back onto air seal head. Slide air seal head/sleeve assembly back into air shaft, bumpers first.
13. Insert lubricated air piston into bottom of upper tube and slide the lower air piston/sleeve assembly into upper tube.
14. Seat the shaft guide ring and wavy washer into upper tube step, then slide negative air sleeve into upper tube and seat shaft guide base into upper tube step.
15. Secure retaining ring into upper tube retaining ring groove using external snap ring pliers. Position retaining ring holes around retaining ring positioner on base plate. Verify retaining ring is secure in upper tube.
16. Measure and pour 6cc/ml of 15wt suspension oil into air tube through the crown. Suspension oil in the air chamber lubricates the air seal o-ring during use and maintains the air seal.
17. Insert top cap into upper tube/crown and hand thread into upper tube. Using a 24 mm socket wrench, tighten to 60 in-lb.

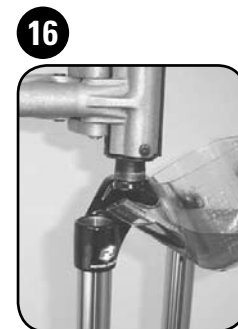
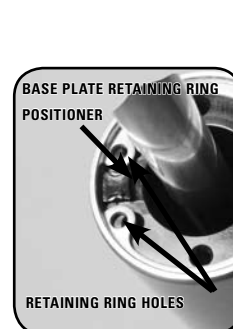

**THIS CONCLUDES THE SPRING SERVICE FOR YOUR FORK. YOU DID A GREAT JOB! YOU ARE NOW READY TO MOVE ON TO THE NEXT SECTION: LOWER LEG INSTALLATION. ENJOY!**



# DUAL AIR SPRING SERVICE

(PIKE 409, 426, 454 - REBA SL, RACE, TEAM, WC - REVELATION 409, 426)

## INTRODUCTION

At this point you should already have the lowers removed from your fork. If not, you will need to return to the Lower Leg Removal section of this manual and follow the instructions for removing your fork lowers.

## DUAL AIR SPRING REMOVAL/SERVICE INSTRUCTIONS

**IMPORTANT: VERIFY ALL AIR PRESSURE IS REMOVED FROM THE AIR CHAMBER BEFORE PROCEEDING. DEPRESS POSITIVE AND NEGATIVE SCHRADER VALVES AGAIN TO REMOVE ANY REMAINING AIR PRESSURE.**

1. Unthread and remove Dual Air top cap with a 24 mm socket wrench.
2. Remove fork from stand and pour any air seal lubricant into oil pan.
3. Clamp fork back into bicycle stand and wipe shaft and base plate with a rag.
4. Push negative air shaft up and into base plate, leaving only the tip of the threaded shaft end protruding from base valve.

**NOTE: YOU MAY NEED TO DEPRESS THE SCHRADER VALVE AS YOU PUSH THE SHAFT, TO PREVENT A VACUUM.**

5. Slide a 15 mm socket tool (or similar hollow tool) over the air shaft end and press firmly against the base plate. While pressing the air base plate up and into the upper tube, remove the retaining ring using external snap ring pliers.
6. Once retaining ring is removed, gently pull air shaft down to remove air spring assembly and base plate from upper tube.
7. Spray isopropyl alcohol on the inside and outside of the upper tube and wipe with a clean rag. Wrap a clean rag around a long dowel and insert into the upper tube to clean inside the upper tube (not pictured).
8. Remove base plate, base plate o-ring/bumper, and negative air piston from the Dual Air shaft.
9. Remove outer and inner negative air piston o-rings. Apply a few drops of suspension oil to new o-rings and re-install.

**IMPORTANT: IF USING A PICK TO REMOVE O-RINGS, DO NOT SCRATCH SEAL HEAD. SCRATCHES MAY CAUSE OIL TO LEAK.**

10. Remove outer positive air piston o-ring. Apply a few drops of suspension oil to new o-ring and re-install.

**IMPORTANT: IF USING A PICK TO REMOVE O-RING, DO NOT SCRATCH SEAL HEAD. SCRATCHES MAY CAUSE OIL TO LEAK.**

1



2



3



4

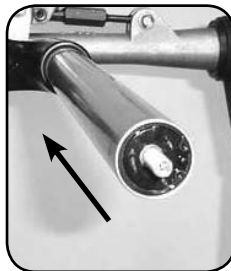

5



6

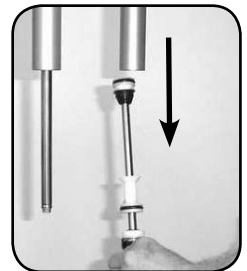

8



9

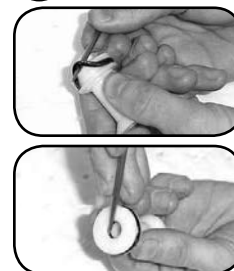

10



## OPTIONAL - ALL TRAVEL CONFIGURATIONS

All travel spacers are located just above the bottom out bumper washer. If you want to change the travel of your fork, snap the travel spacer onto the Dual Air shaft to decrease travel, or remove to increase travel.

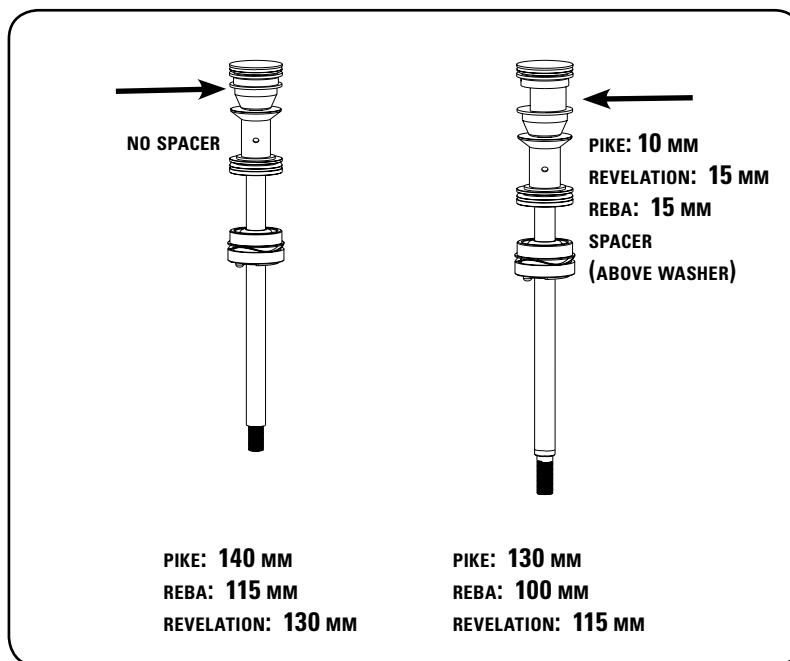

## DUAL AIR SPRING INSTALLATION INSTRUCTIONS

11. Re-install the negative air piston, base plate o-ring/bumper and base plate onto the Dual Air shaft and re-apply suspension oil to o-rings.
12. Insert Dual Air assembly into upper tube, positive air piston first, followed by the negative air piston. Insert base plate assembly into upper tube step and press in firmly.
13. Using your thumb, press base plate into upper tube. While pressing base plate, install external retaining ring using external snap ring pliers. Verify retaining ring is secure in upper tube groove. Align retaining ring according to the orientation of the base plate retaining ring groove.
14. Measure and pour 6cc/ml of 15wt suspension oil into air tube through crown. Suspension oil in the air chamber lubricates the air seal o-ring during use and maintains the air seal.
15. Insert top cap into upper tube/crown and hand thread into upper tube. Using a 24 mm socket wrench, tighten to 60 in-lb.

11



12

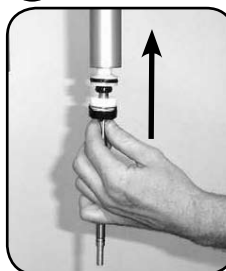

13



14



15



**THIS CONCLUDES THE SPRING SERVICE FOR YOUR FORK. YOU DID A GREAT JOB! YOU ARE NOW READY TO MOVE ON TO THE NEXT SECTION: LOWER LEG INSTALLATION. ENJOY!**

# DUAL AIR SPRING SERVICE

(SID RACE, TEAM, WC)

## INTRODUCTION

At this point you should already have the lowers removed from your fork. If not, you will need to return to the Lower Leg Removal section of this manual and follow the instructions for removing your fork lowers.

## DUAL AIR SPRING REMOVAL/SERVICE INSTRUCTIONS

**IMPORTANT: VERIFY ALL AIR PRESSURE IS REMOVED FROM THE AIR CHAMBER BEFORE PROCEEDING. DEPRESS POSITIVE AND NEGATIVE SCHRADER VALVES AGAIN TO REMOVE ANY REMAINING AIR PRESSURE.**

1. Unthread and remove Dual Air spring top cap with a 24 mm socket wrench.
2. Remove fork from stand and pour any oil from positive air chamber into oil pan.
3. Remove threaded upper tube retainer using the SID Dual Air upper tube retainer tool and a socket wrench.

**IMPORTANT: THE RETAINER IS REVERSE THREADED. TURN THE WRENCH **CLOCKWISE** TO UNTHREAD.**

4. Pull Dual Air spring shaft assembly from upper tube.

**NOTE: YOU MAY NEED TO DEPRESS THE NEGATIVE SCHRADER VALVE AS YOU PULL THE DUAL AIR SHAFT; PRESSURE BUILDS UP AS YOU PULL.**

5. Spray isopropyl alcohol on the inside and outside of the upper tube and wipe with a clean rag. Wrap a clean rag around a long dowel and insert into the upper tube to clean inside the upper tube (not pictured).

**IMPORTANT: LOOK INSIDE THE UPPER TUBE USING A LIGHT AND CHECK FOR SCRATCHES. IF THE INSIDE SURFACE OF THE UPPER TUBE IS SCRATCHED, REPLACE THE ASSEMBLY. SCRATCHES CAN CAUSE AIR BYPASS AND EFFECT THE PERFORMANCE OF YOUR FORK.**

6. Slide the negative air piston sleeve from air spring shaft.
7. Spray isopropyl alcohol on the air shaft and wipe with a clean rag (not pictured).
8. Remove the outer and inner negative air piston o-rings as well as the outer positive air piston o-ring. Apply a few drops of suspension oil to new o-rings and re-install.

**IMPORTANT: IF USING A PICK TO REMOVE O-RINGS, DO NOT SCRATCH SEAL HEAD. SCRATCHES MAY CAUSE OIL TO LEAK.**

9. Slide negative air spring sleeve back onto air spring shaft.

1



2



3



4



6

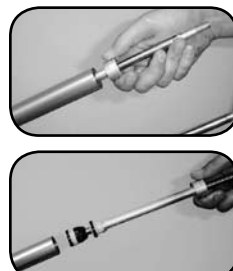

6

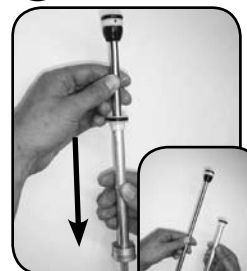

8



9

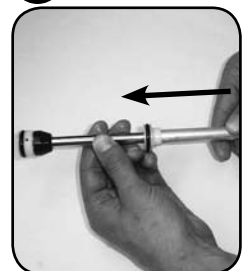



## OPTIONAL - ALL TRAVEL CONFIGURATIONS

All travel spacers are located just above the negative sleeve top out bumper. To change the travel of your fork, slide negative sleeve down and snap the travel spacer onto seal head to decrease travel, or remove to increase travel.

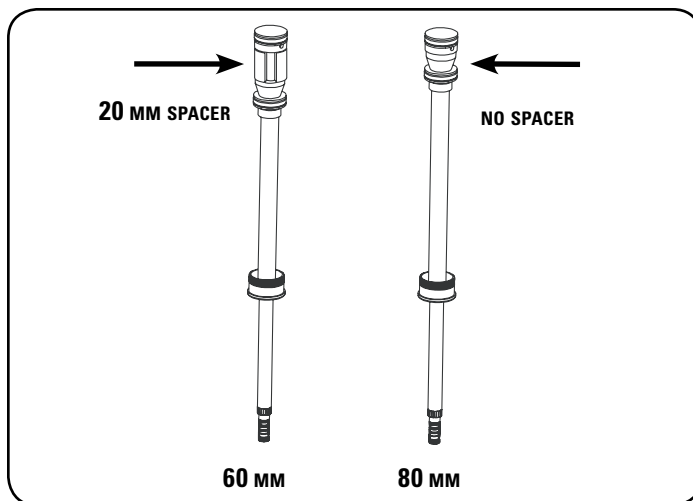

## DUAL AIR SPRING INSTALLATION INSTRUCTIONS

10. Re-apply fresh suspension oil to new positive and negative air piston o-rings.
11. Insert positive air piston into bottom of upper tube and push air piston/shaft assembly into upper tube.
12. Slide the negative air piston sleeve down air spring shaft and into the bottom of the upper tube. Continue to slide entire negative air spring sleeve into upper tube.

**NOTE: YOU MAY NEED TO DEPRESS THE NEGATIVE SCHRADER AIR VALVE AS YOU PUSH THE NEGATIVE SLEEVE INTO THE UPPER TUBE TO RELEASE THE AIR PRESSURE BUILD UP AND AID IN INSTALLATION.**

13. Thread Dual Air spring assembly threaded base retainer into the upper tube by hand. Using the SID Dual Air upper tube retainer tool and a socket wrench, press into retainer firmly and tighten the threaded upper tube/base retainer to 30 in-lb.

**IMPORTANT: THE RETAINER IS REVERSE THREADED. TURN BY HAND AND WRENCH COUNTER-CLOCKWISE TO THREAD.**

14. Make sure fork is positioned upright in workstand. Measure and pour 6cc/ml of 15wt suspension oil into positive air chamber, through the crown.

**NOTE: SUSPENSION OIL ON TOP OF THE POSITIVE AIR PISTON O-RING IS CRITICAL TO LUBRICATION AND MAINTENANCE OF THE AIR SEAL.**

15. Insert top cap into upper tube/crown and hand thread into upper tube. Using a 24 mm socket wrench, tighten to 60 in-lb.

**THIS CONCLUDES THE SPRING SERVICE FOR YOUR FORK. YOU DID A GREAT JOB! YOU ARE NOW READY TO MOVE ON TO THE NEXT SECTION: LOWER LEG INSTALLATION. ENJOY!**

10



11

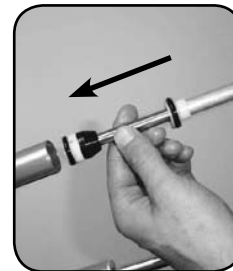

12



13



14



15



# AIR U-TURN SPRING SERVICE

(PIKE 409, 429, 454 - REBA RACE, TEAM - REVELATION 409, 429)

## INTRODUCTION

At this point you should already have the lowers removed from your fork. If not, you will need to return to the Lower Leg Removal section of this manual and follow the instructions for removing your fork lowers.

## AIR U-TURN SPRING REMOVAL/SERVICE INSTRUCTIONS

**IMPORTANT: VERIFY ALL AIR PRESSURE IS REMOVED FROM THE AIR CHAMBER BEFORE PROCEEDING. DEPRESS POSITIVE AND NEGATIVE SCHRADER VALVES AGAIN TO REMOVE ANY REMAINING AIR PRESSURE.**

1. Adjust travel setting to max (full) travel. Push external retaining clip from above U-Turn knob with a pick or screwdriver and remove adjuster knob.
2. Remove detent ball bearings and detent springs from top cap using a magnet.

**IMPORTANT: IT IS NOT NECESSARY TO REMOVE THE U-TURN TOP CAP TO SERVICE THE AIR U-TURN SPRING ASSEMBLY. IN THE EVENT THE TOP CAP MUST BE REMOVED, UNTHREAD WITH A 24 MM SOCKET WRENCH. BEFORE RE-INSTALLING TOP CAP, CLEAN OLD THREAD-LOCK OFF TOP CAP. THEN ADD A FEW DROPS OF BLUE THREAD-LOCK TO THE TOP CAP THREADS AND TIGHTEN WITH SOCKET WRENCH TO 60 IN-LB.**

3. Turn Air U-Turn travel adjust shaft, which protrudes from both the center of the top cap and the bottom of the air shaft, **CLOCKWISE** to unthread the air spring assembly from the Air U-Turn top cap (top cap should be tight inside crown/upper tube).
4. Pull down on the Air U-Turn shaft and remove the entire spring assembly from the bottom of the upper tube.
5. Remove teflon washer from inside of top cap. To remove, push down with a pick or flat-head screwdriver. Washer will exit bottom of the upper tube.
6. Remove small external retaining ring located at the bottom of the air chamber using external snap ring pliers, then remove guide plate.
7. Push down on seal head with a flat-head screwdriver (position screwdriver head against step, away from shaft) and free the retaining ring from the seal head. Once seal head slides into air tube, remove seal head retaining ring, using snap ring pliers.

**IMPORTANT: DO NOT SCRATCH AIR SHAFT. SCRATCHES WITH CAUSE AIR TO LEAK AND EFFECT THE PERFORMANCE OF YOUR FORK.**

1



2



3

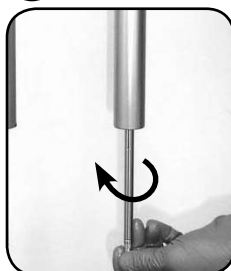

4

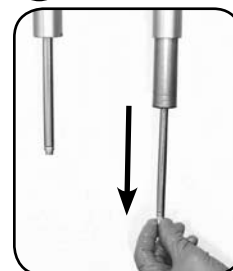

5



6



7



## AIR U-TURN SPRING REMOVAL/SERVICE INSTRUCTIONS (CONT)

8. Pull air shaft, negative air seal head and positive air piston assemblies out of air tube. Slide and remove aluminum seal head from air shaft.
9. Spray isopropyl alcohol on air shaft and wipe with a clean rag (not pictured).

10. Remove seal head from air piston shaft. Remove the inner and outer seal head o-rings as well as the small outer o-ring located on the air piston shaft groove. Apply a few drops of suspension oil to new o-rings and re-install.

**IMPORTANT: IF USING A PICK TO REMOVE O-RINGS, DO NOT SCRATCH SEAL HEAD OR O-RINGS. SCRATCHES WILL CAUSE PERMANENT AIR LEAK.**

11. Holding the air tube, place upper choke assembly end of flat surface. Firmly press tube down on flat surface to break the seal and push choke assembly through tube.

**NOTE: THE CHOKE ASSEMBLY WILL FEEL TIGHT INSIDE TUBE WHILE PUSHING CHOKE OUT OF AIR TUBE. YOU MAY NEED TO TAP THE END OF THE AIR SHAFT ON A FLAT WORKING SURFACE TO FREE THE UPPER AIR SPRING ASSEMBLY FROM THE AIR TUBE.**

12. Use a non-metallic dowel to continue to push the assembly through and out of the air tube. Remove assembly completely from air tube.

**IMPORTANT: USING A NON-METALLIC DOWEL HELPS TO ENSURE THE INSIDE OF THE AIR TUBE DOES NOT GET SCRATCHED.**

13. Spray isopropyl alcohol on the inside and outside of the air tube and wipe with a clean rag. Wrap a clean rag around a long dowel and insert into the upper tube to clean inside the upper tube (not pictured).

14. Remove external choke retaining ring from travel adjustment shaft, using external snap ring pliers. Remove choke piston and choke/shaft washer.

15. Remove external choke o-ring. Apply a few drops of suspension oil to new o-ring and re-install.

**IMPORTANT: IF USING A PICK TO REMOVE O-RING, DO NOT SCRATCH CHOKE PISTON. SCRATCHES MAY CAUSE AIR LEAK.**

16. Remove upper seal head from adjuster shaft.
17. Use a flat head screwdriver and remove inner o-ring retaining ring. Then remove both the inner and outer seal head o-rings. Apply a few drops of suspension oil to new o-rings and re-install. Use a flat head screwdriver to re-install inner o-ring retaining ring.

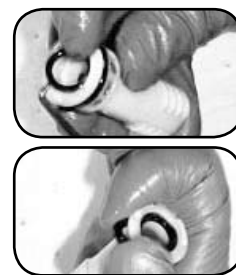
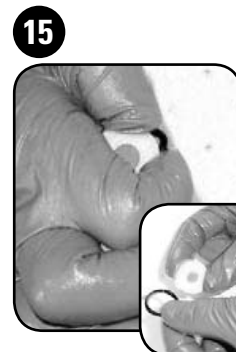
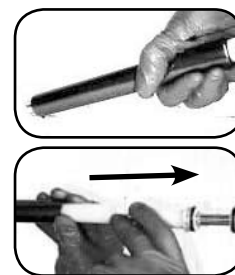
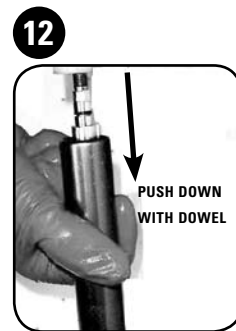
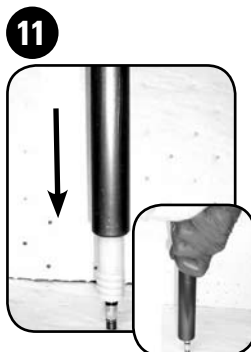
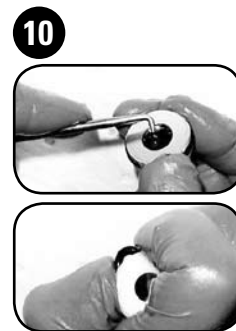
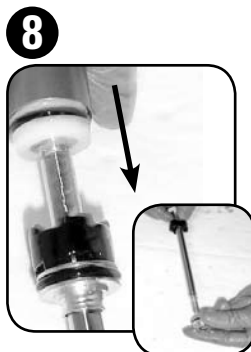

## AIR U-TURN SPRING REMOVAL/SERVICE INSTRUCTIONS (CONT)

18. Re-install upper seal head onto travel adjustment shaft and apply suspension oil to adjuster shaft and inner seal head o-ring.
19. Install choke piston and secure with a NEW 10 mm external retaining ring, using external snap ring pliers.
20. Apply suspension oil to both piston o-rings.

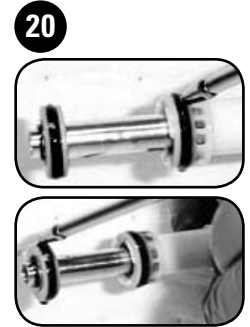

## AIR U-TURN SPRING INSTALLATION INSTRUCTIONS

21. Apply a thin film of grease to the inside groove of the open end of the air spring tube. Insert the upper choke assembly into open end of air spring tube, schrader valve first, and press completely into air tube.
22. Using a long non-metallic dowel, push assembly up into the air tube until seated flush against the rolled end of the air tube.
23. Hold air tube with open end up. Measure and pour 6cc/ml of 15wt suspension oil into air tube/positive air chamber, on top of the upper choke assembly. This will lubricate the choke o-ring and positive air piston o-ring when fork is compressed. Set aside air tube, upright, so oil does not spill.
24. Re-apply suspension oil to inner seal head o-ring and slide negative air seal head onto Dual Air shaft, flat end first. Slide up to bottom out bumper.
25. Re-apply suspension oil to positive and negative air piston o-rings and insert positive air piston into open end of air spring. Push air shaft assembly into air tube.
26. Using a small flathead screwdriver, press down on seal head shaft step to seat into place inside air tube. Secure seal head into air tube with retaining ring, using internal snap ring pliers. **IMPORTANT: RETAINING RING MUST BE FULLY SEATED IN UPPER TUBE GROOVE. CHECK RETAINING RING CLOSELY TO ENSURE SECURE FIT.**
27. Add air to the positive air chamber (40-60psi) to ensure assembly components are seated properly inside air tube.

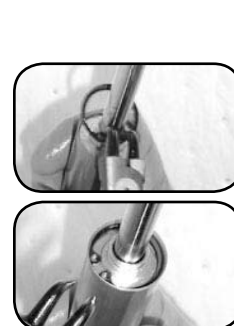
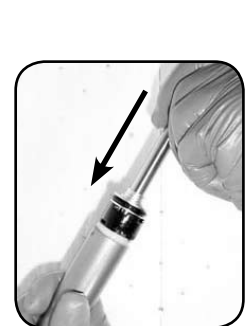
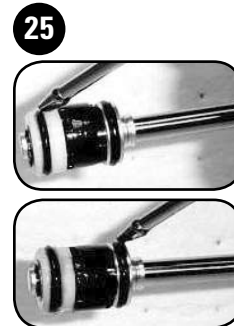
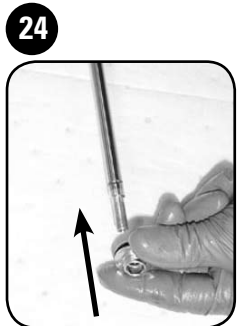

## AIR U-TURN SPRING INSTALLATION INSTRUCTIONS (CONT)

28. Insert air tube guide plate into the end of air tube. Secure around small seal head groove with a new 13 mm external retaining ring, using external snap ring pliers. Verify retaining ring is seated against guide plate so it cannot move freely.

**IMPORTANT: EXTERNAL RETAINING RINGS MAY DEFORM WHEN REMOVED AND INSTALLED. PINCH ENDS TIGHT WITH PLIERS, TO ENSURE CORRECT FIT.**

**NOTE: THE U-TURN AIR ASSEMBLY IS NOW ASSEMBLED AND READY TO BE INSTALLED INTO FORK UPPER TUBE/CROWN.**

29. Place Teflon washer over threaded shaft end, flat against travel shaft. Insert Air U-Turn assembly into bottom of left fork upper tube, adjuster end first.
30. Slide into upper tube until upper assembly engages top cap. Thread assembly into top cap by holding the bottom of the air shaft and turning **Counter-clockwise** until it stops.
31. Insert each detent spring into top cap detent holes, evenly spaced. Place each detent ball bearing on top of each detent spring.
32. Place Air U-Turn adjuster knob on hex shaft end. Secure knob on air shaft with external retaining ring, using external snap ring pliers. Make sure retaining ring is inserted into groove, not air shaft threads.

**IMPORTANT: AIR U-TURN FORK **MUST** BE SET TO FULL TRAVEL SETTING BEFORE INSTALLING LOWER LEGS. TURN AIR U-TURN KNOB COUNTER-CLOCKWISE TO SET TO FULL TRAVEL.**

**THIS CONCLUDES THE SPRING SERVICE FOR YOUR FORK. YOU DID A GREAT JOB! YOU ARE NOW READY TO MOVE ON TO THE NEXT SECTION: LOWER LEG INSTALLATION. ENJOY!**

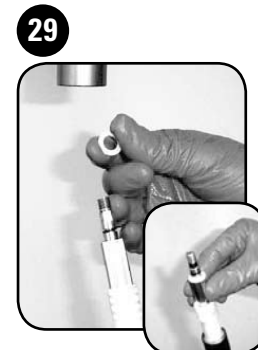
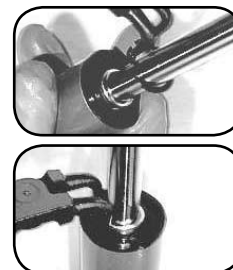

# 2-STEP AIR SPRING SERVICE

(LYRIK - TOTEM)

## INTRODUCTION

At this point you should already have the lowers removed from your fork. If not, you will need to return to the Lower Leg Removal section of this manual and follow the instructions for removing your fork lowers.

## 2-STEP AIR SPRING REMOVAL/SERVICE INSTRUCTIONS

1. Remove all air pressure from the system by depressing air valve at the bottom of the left leg, and then remove the 2-Step schrader valve using a Schrader valve tool.

**WARNING: VERIFY ALL PRESSURE IS REMOVED FROM THE AIR CHAMBER BEFORE PROCEEDING.**

2. Using a 2 mm hex wrench remove 2-Step adjuster fixing screw and control knob.
3. Using a 24 mm socket wrench, unthread and remove the 2-Step top cap. Inspect 2-Step top cap o-ring for damage. Replace if necessary.
4. Remove fork from bicycle stand and pour any remaining oil into oil pan. Return fork to bicycle stand.

5. Using external snap ring pliers, remove retaining ring from the bottom of the left upper tube.
6. Gently pull down on the air shaft to remove the entire 2-Step assembly.
7. Remove lower seal head from shaft assembly and set aside.
8. Separate the 2-Step assembly into 3 parts: shaft assembly, air tube, and piston housing (in order in picture).

**IMPORTANT: AVOID PULLING THE SHAFT PAST THE BLEED HOLES ON THE AIR TUBE AS THIS MAY DAMAGE THE O-RINGS. REMOVE SHAFT OUT OF THE TOP OF AIR TUBE OPPOSITE THE BLEED HOLES.**

9. Remove piston from the IFP piston housing. Inspect IFP piston housing for damage or scratches, paying close attention the inside surface of the IFP piston housing. If damaged or scratched, replace the IFP piston housing.
10. Remove piston o-ring. Clean piston with isopropyl alcohol. Apply a few drops of suspension oil to new o-ring and re-install.

**IMPORTANT: IF USING A PICK TO REMOVE O-RINGS, DO NOT SCRATCH LOWER SEAL HEAD OR O-RINGS. SCRATCHES WILL CAUSE PERMANENT AIR LEAK.**

1

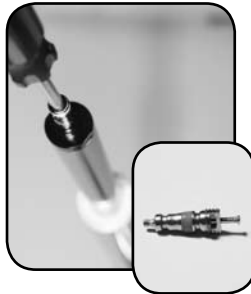

2



3



4



5



6



7



8



9



10



## 2-STEP AIR SPRING REMOVAL/SERVICE INSTRUCTIONS (CONT)

11. Inspect IFP piston housing o-ring for damage. Replace if necessary. Re-assemble IFP and IFP piston housing. The IFP should be inserted into the housing with the o-ring side down. Press the IFP into the IFP piston housing until it bottoms out completely.

**NOTE: IMPROPER INSTALLATION OF THE IFP WILL CHANGE 2-STEP AIR SPRING PERFORMANCE AND/OR AFFECT THE SYSTEM'S ABILITY TO ACHIEVE FULL TRAVEL ADJUSTMENT RANGE.**

11



13



12. Spray isopropyl alcohol on the inside and outside of the air tube and wipe with a clean rag. Wrap a clean rag around a long dowel and insert into the upper tube to clean inside the upper tube. Inspect the air tube for damage and scratches. Replace if damaged or scratched (not pictured).

14

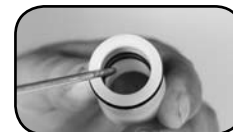
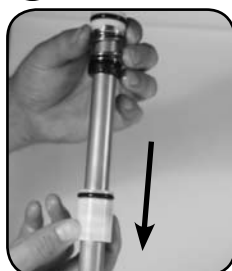

15



13. Return to lower seal head. Remove inner and outer lower seal head o-rings. Apply a few drops of suspension oil to new o-rings and re-install.

**IMPORTANT: IF USING A PICK TO REMOVE O-RINGS, DO NOT SCRATCH LOWER SEAL HEAD OR O-RINGS. SCRATCHES WILL CAUSE PERMANENT AIR LEAK.**

16



17



14. Remove lower floating piston from the air shaft assembly. Remove lower floating piston inner and outer o-rings. Spray lower floating piston with isopropyl alcohol and wipe with a clean rag. Apply a few drops of suspension oil to new o-rings and re-install.

15. Remove rubber cushion and using a flat head screw driver, carefully remove top out spring assembly from the air shaft. Spray with isopropyl alcohol and wipe with a clean rag.

16. Using external snap ring pliers, remove the retaining ring and wavy spring washer located on top of the main piston.

17. Remove the inner and outer piston o-rings. Spray the main piston with isopropyl alcohol and wipe with a clean rag. Apply a few drops of suspension oil to new o-rings and re-install.

## 2-STEP AIR SPRING INSTALLATION INSTRUCTIONS

18. Inspect the face seal o-ring, making sure it is seated properly. A properly seated o-ring will not have any distortion in its shape (not pictured).
19. Spray air shaft with isopropyl alcohol and wipe with a clean rag. Inspect air shaft for damage or scratches. Replace if damaged or scratched (not pictured).

## 2-STEP AIR SPRING INSTALLATION INSTRUCTIONS (CONT)

20. Reassemble main piston and kick plate and install onto air shaft. Slide wavy washer on top of main piston and secure into place with snap ring.
21. Install top out spring assembly, rubber cushion, and lower floating piston onto air shaft. Do not install lower seal head at this time.
22. Install shaft assembly into air tube, air valve first, in the side opposite the two holes on the air tube. Install lower seal head on shaft assembly.
23. Measure and pour 5cc/ml of 15wt suspension oil into the top of the air tube assembly.
24. Insert the IFP piston housing into the air tube assembly, being careful not to spill the oil already in air tube.
25. Insert the 2-Step assembly into the bottom of the upper tube. Secure with retaining ring. **IMPORTANT: RETAINING RING MUST BE FULLY SEATED IN UPPER TUBE GROOVE. CHECK RETAINING RING CLOSELY TO ENSURE SECURE FIT.**
26. Gently pull down on air shaft to extend to maximum length.
27. Lyrik Only: Measure and pour 35cc/ml of 2.5wt suspension oil into the top of the upper tube. Totem Only: Measure and pour 135cc/ml of 2.5wt suspension oil into the top of the upper tube.  
**TIP: TAP THE SIDE OF THE UPPER TUBE WITH YOUR HAND, THEN GENTLY WIGGLE THE SHAFT SIDE TO SIDE TO BRING ANY TRAPPED AIR BUBBLES TO THE TOP. GENTLY PULL DOWN ON AIR SHAFT AGAIN TO MAKE SURE IT IS AT FULL EXTENSION.**  
**NOTE: THE OIL WILL JUST REACH THE BOTTOM OF THE UPPER TUBE THREADS, REMOVE ANY EXCESS OIL.**  
**IMPORTANT: AS LITTLE AS 2cc/ML CAN MAKE A DIFFERENCE IN THE TRAVEL ADJUSTMENT PERFORMANCE. TOO LITTLE OIL WILL RESULT IN LIMITED TRAVEL ADJUSTMENT RANGE. TOO MUCH OIL WILL CHANGE FORK HEIGHT.**
28. Insert top cap into upper tube/crown and hand thread into upper tube. Using the 2-Step adjuster knob, turn the adjuster to the minimum travel setting. Remove the adjuster knob and using a 24 mm socket wrench, tighten top cap to 60 in-lb.
29. Install 2-Step adjuster knob and secure fixing screw with a 2 mm hex wrench.
30. Install schrader valve into bottom of air shaft, using schrader valve tool.
31. Add 100psi to the 2-Step system. Rotate adjuster knob to minimum travel position and compress air shaft to ensure proper function. Rotate adjuster knob to full travel position and verify return to full extension.

20



21



22



23



23



24



25



26

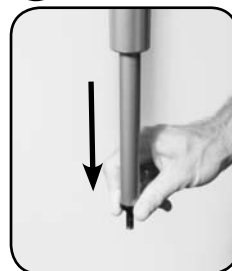

27



28



29



30



31



**THIS CONCLUDES THE SPRING SERVICE FOR YOUR FORK.**



# LOWER LEG INSTALLATION



# LOWER LEG INSTALLATION

(ALL FORKS)

## INTRODUCTION

At this point you should already have already serviced your fork bushings, damper system, and spring system. Once you have re-installed your fork lowers, you will have successfully serviced your fork and you will be ready to ride!

## LOWER LEG INSTALLATION INSTRUCTIONS

1. Spray upper tubes with isopropyl alcohol and wipe with a clean rag (not pictured).
2. Pour or inject 15wt suspension oil onto new or clean foam rings, just under dust seals inside each lower leg.
3. Slide lower leg assembly on the upper tubes until you feel the lower bushing touch the end of the upper tubes.

**IMPORTANT: MAKE SURE BOTH DUST SEALS SLIDE ONTO THE TUBES CORRECTLY AND DO NOT FOLD UNDER.**

4. Invert fork to about 45°, fork legs pointing upward. Measure and inject suspension oil into lower legs through each shaft bolt hole, according the bottom volume values found in the Oil Volume chart located in the Getting Started Information section of this manual. Wipe all excess oil from lower legs.

**NOTE: BOXXER ONLY - SLIDE DAMPER SIDE FORK LEG BACK ONTO UPPER TUBE UNTIL THE LOWER BUSHING TOUCHES THE END OF THE UPPER TUBE AFTER INJECTING OIL.**

4. Inspect and clean air spring shaft bolts, black nylon crush washers and crush wash retainers. Replace crush washers and crush washer retainers if damaged (not pictured).

**NOTE: DAMAGED OR DIRTY CRUSH WASHERS CAN CAUSE OIL TO LEAK.**

6. Insert rebound damper and air spring shaft bolts into threaded shaft ends, through lower leg shaft holes and tighten with a 5 mm hex or 10 mm socket wrench to 60in-lb.

2



3



4



6



## LOWER LEG INSTALLATION INSTRUCTIONS (CONT)

**NOTE: BOXXER ONLY - INSERT EACH UPPER TUBE EVENLY INTO THE LOWER CROWN. PULL UPPER TUBES UP AND INTO THE CROWN, TWISTING GENTLY AS THE UPPER TUBES EASE INTO THE HOLES. PULL LEFT (DAMPER SIDE) UPPER TUBE UP TO THE FULLY EXTENDED POSITION (DO NOT OVER EXTEND!). MEASURE 205 MM FROM THE DUST/LOWER LEG TO THE BOTTOM OF THE LOWER CROWN HOLE AND TIGHTEN THE CROWN BOLT WITH A 4 MM HEX TO 65 IN/LB. PULL THE RIGHT (SPRING SIDE) UPPER TUBE EVEN WITH THE LEFT AND TIGHTEN THE CROWN BOLT TO 65 IN/LB. MAKE SURE THE UPPER TUBES ARE POSITIONED AT AN EVEN HEIGHT!**

**REFER TO THE DIAGRAM FOR CROWN MEASUREMENTS. SLIDE EACH UPPER TUBE/FRAME BUMPER ONTO EACH UPPER TUBE. INSTALL UPPER CROWN ON UPPER TUBES AND STEERER TUBE. REFER TO THE DIAGRAM FOR APPROPRIATE MEASUREMENTS. TIGHTEN UPPER CROWN WITH A 4 MM HEX WRENCH TO 65 IN-LB.**

7. Insert external rebound damper knob into rebound damper shaft bolt. Push in until secure. Adjust as desired.
8. For air spring forks, refer to the air chart on your fork and inflate positive and negative air chambers to appropriate psi. For coil forks, move to Step 9.
9. Spray isopropyl alcohol on entire fork and wipe with a clean rag (not pictured).
10. Thread positive and negative air valve cap covers onto air top cap.

**THIS CONCLUDES THE SERVICE FOR YOUR FORK. YOU DID A GREAT JOB! YOU ARE NOW READY TO INSTALL YOUR FORK ON YOUR BIKE AND GO FOR A RIDE!**

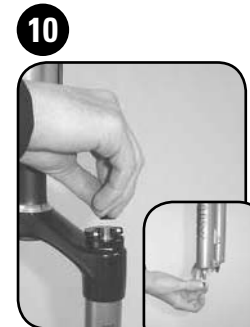
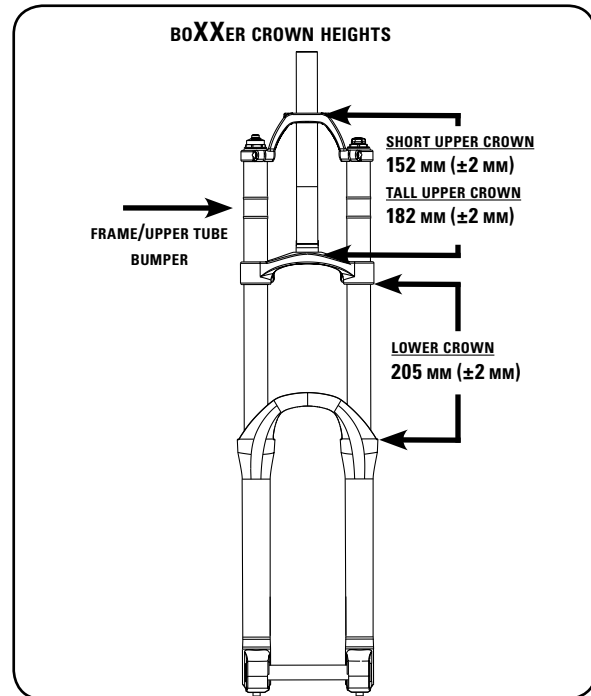



# i-RIDE SPRING SERVICE



# i-RIDE SPRING SERVICE

## INTRODUCTION

To maintain the high performance, safety, and long life of your i-Ride fork, periodic maintenance is required. If you ride in extreme conditions, maintenance should be performed more frequently.

## SERVICE INSTRUCTIONS

### REMOVE i-RIDE FORK FROM THE BIKE (NOT PICTURED)

1. Remove the front wheel.
2. Remove the front brake.
3. **i-Ride:** Using a 5 mm hex, remove the headset bolt, then remove the headset cap.  
**i-Ride with M10 star nut:** Using an 8 mm hex, remove the headset bolt, then remove the headset cap.
4. Loosen the stem bolt(s) and remove the stem with the handlebar intact.
5. Carefully pull the fork down out of the headtube. Retain spacers and headset parts as you go.

### DISASSEMBLE STEERER ASSEMBLY

6. With the front side of the i-Ride fork facing you, locate the top of the steerer tube and write the word 'front' on the steerer tube in permanent marker.
7. Using either a 14 mm socket on the end of a socket extension or a long 6 mm hex, loosen and remove the retaining nut. Invert the fork and let the lock washer fall into your hand.

**NOTE: IF THE LOCK WASHER DOESN'T FALL OUT, USE A PICK TO PULL THE LOCK WASHER OFF OF THE THREADED INSERT AND OUT OF THE STEERER.**

**i-Ride with M10 star nut:** Using a long 6 mm hex through the center of the star nut, loosen the retaining nut. Using a pick, pull the lock washer off of the threaded insert.

**NOTE: THE NUT AND THE WASHER WILL REMAIN IN THE STEERER TUBE BETWEEN THE STAR NUT AND THE BASEPLATE, LOCATED INSIDE THE OUTER STEERER.**

**TIP: LEAVE THE LONG 6 MM HEX WRENCH IN THE RETAINING NUT AND LOCK WASHER TO KEEP THEM ALIGNED WITHIN THE STEERER TUBE. THIS WILL EASE RE-ASSEMBLY LATER.**

8. **i-Ride:** Clean the retaining nut with isopropyl alcohol and wipe with a clean rag. Apply blue threadlock (Loctite 2440) to the threads per manufacturer's instructions (not pictured). This will allow time for the threadlock to dry.
9. Carefully cut the zip tie securing the boot to the outer steerer, and pull the bottom of the boot over the lower leg crown flange.

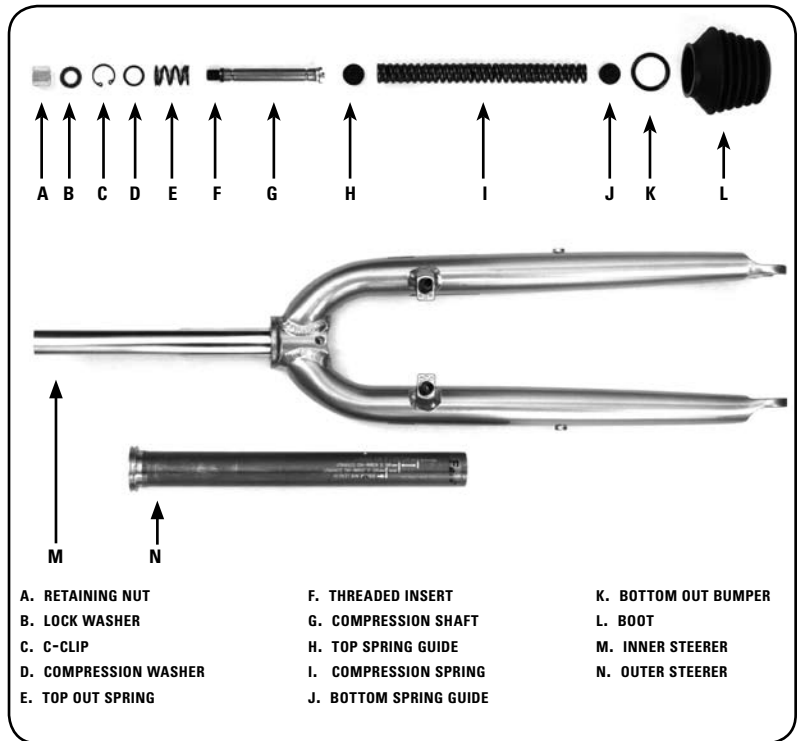

6



7



9

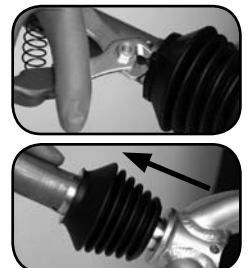

## SERVICE INSTRUCTIONS (CONT)

10. Pull the outer steerer upwards until it clears the inner steerer and remove.

**NOTE: IF THE OUTER STEERER DOES NOT EASILY SEPARATE FROM THE INNER STEERER, PLACE A DOWEL ROD ON TOP OF THE THREADED INSERT AND FIRMLY STRIKE THE ROD WITH A MALLET TO LOOSEN THE OUTER STEERER.**

11. Remove the boot and the bottom out bumper.

### REMOVE COIL SPRING, CLEAN AND LUBRICATE

12. Using a cloth to protect the palm of your hand, compress the coil spring by pressing down on the threaded insert. It is not necessary to fully compress the spring, just press enough to relieve pressure on the retaining c-clip.

**NOTE: YOU MAY WANT TO PLACE THE FORK BETWEEN YOUR FEET TO STABILIZE THE FORK DURING THIS PROCESS.**

13. Using snap ring pliers while the spring is compressed, remove the retaining c-clip from within the inner steerer. The spring assembly will decompress and rise out of the inner steerer.

**IMPORTANT: MAINTAIN CONTROL OF THE SPRING ASSEMBLY AS IT RISES OUT OF THE INNER STEERER SO IT DOES NOT RAPIDLY EJECT AND HARM YOU OR YOUR SURROUNDINGS.**

14. Separate the compression washer, top out spring, compression shaft, top spring guide, and compression spring.

15. Locate the underside of the fork crown. Using a long, 7 mm (1/4") diameter dowel push the bottom spring guide out of the inner steerer.

16. Spray all parts with isopropyl alcohol and wipe with a clean rag. Inspect all parts for wear (not pictured).

17. Generously apply grease to compression and top out springs.

18. Insert the spring guides into the compression spring. Slide the compression spring assembly into the inner steerer.

19. Slide the top-out spring, washer, and c-clip over the compression shaft assembly. Slide the compression shaft assembly into inner steerer.

20. Using a cloth to protect the palm of your hand, compress the compression spring by pressing down on the threaded insert. Using snap ring pliers, re-install the c-clip.

**IMPORTANT: VERIFY THE C-CLIP IS FULLY SEATED BEFORE DECOMPRESSING THE SPRING.**

**NOTE: THE C-CLIP PROFILE HAS A ROUNDED EDGE AND A SHARP EDGE. MAKE SURE THE SHARP EDGE OF THE C-CLIP IS FACING UP, AWAY FROM THE FORK.**

10



11



12



13



14



15



17



18



19



20



## SERVICE INSTRUCTIONS

### INSPECT, CLEAN, AND GREASE STEERER ASSEMBLY

#### OUTER STEERER

21. Spray isopropyl alcohol inside the outer steerer. Wrap a clean rag around a dowel and clean the inside of the outer steerer.
22. Inspect the bushings and inside steerer surface for excessive wear. (not pictured)
23. Using a grease brush, apply a medium coat of grease (Maxima SG-920) to the bushings and D-slot flats.

21



23



#### INNER STEERER

24. Spray isopropyl alcohol on the inside and outside of the inner steerer tube. Wrap a clean rag around a dowel and clean the inside of the inner steerer. Clean the outside of the inner steerer tube with a rag.
25. Spray isopropyl alcohol on the bottom-out bumper and clean with a rag. Inspect the bottom-out bumper for damage and replace if necessary (not pictured).
26. Inspect the steerer surface for excessive wear (not pictured).
27. Re-install the bottom out bumper by sliding it to the base of the steerer.
28. Using a grease brush, apply a liberal coating of grease (Maxima SG-920) to the inner steerer.

24

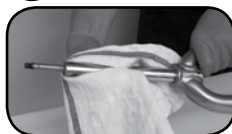

25



28



29



#### BOOT

29. Clean the boot with soapy water. Inspect for cuts or damage, and replace if necessary.  
**NOTE: THE FLAT NOTCH ON THE BOOT FLANGE IS A DESIGN FEATURE AND IS NOT A SIGN OF DAMAGE.**

### ASSEMBLE THE STEERER ASSEMBLY

30. Align the steerer so the word 'front' is facing you. Slide the outer steerer over the inner steerer, watching through the top for the threaded insert to align and pass through the baseplate. Wipe off any excess grease.  
**TIP: USE THE PICK TO GUIDE THE THREADED INSERT THROUGH THE BASEPLATE IF NECESSARY.**
31. Wet a small patch of a clean cloth with isopropyl alcohol. Using a dowel rod to work the cloth into the steerer to clean any grease from the threaded insert (not pictured).
32. Using a 6 mm hex, position the lock washer and retaining nut onto the threaded insert.  
**i-Ride with M10 star nut:** Using a pick or 6 mm hex wrench, align the lock washer over the threaded insert as you bring the steerers into position and position the retaining nut on top of the threaded insert. Pass a long 6 mm hex through the center of the star nut and tighten the retaining nut. Do not over tighten.

30

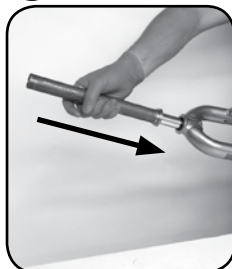

32





## SERVICE INSTRUCTIONS

33. Using a torque wrench with a 14 mm socket extension tighten the retaining nut to 120in-lb (13.6 Nm).
34. Place the top of the boot over the flange on the outer steerer so that the flat notch on the boot is on the back side of the fork.  
**NOTE: THE TOP OF THE BOOT FLANGE HAS A FLAT AREA ON THE CIRCUMFERENCE. THIS IS THE 'BACK' OF THE BOOT.**
35. Pull the bottom of the boot over the lower leg crown flange, then align a zip tie in the groove at the top of the boot so that the fastener is in the middle of the flat notch on the top boot flange. Tighten the zip tie on the back of the boot and cut off the excess.
36. Check the function of the fork. Re-install fork and brake caliper according to manufacturer's instructions (not pictured).

33



34



35





# REAR SHOCK SERVICE



# TOOLS NEEDED FOR SERVICE (REAR SHOCKS)

The following chart is a list of the model year 2008 tools needed for service on your RockShox rear shock. While this chart is intended to be comprehensive, it is still only a guide. The tools required for each step of service are detailed in the text of each service section. Keep in mind your specific shock may not require every tool listed.

TOOLS	ARIO - BAR MC - PEARL	Monarch	Vivid
<b>SAFETY/STARTING EQUIPMENT</b>			
SAFETY GLASSES	X	X	X
APRON	X	X	X
RUBBER GLOVES	X	X	X
CLEAN RAGS (LINT FREE)	X	X	X
OIL PAN	X	X	X
CLEAN WORK AREA	X	X	X
BENCH VICE	X	X	X
SOFT JAWS	X	X	X
SHAFT CLAMP			X
<b>WRENCHES/PLIERS</b>			
1.5 mm HEX		X	
2 mm HEX		X	X
2.5 mm HEX		X	X
13 mm WRENCH			X
30 mm THIN WRENCH			X
ADJUSTABLE WRENCH		X	X
CROW'S FOOT WRENCH		X	
TORQUE WRENCH		X	X
T-10 TORX® WRENCH			X
24 mm PIN SPANNER			X
SLIP JOINT PLIERS	X		
<b>MISC TOOLS</b>			
AIR COMPRESSOR WITH BLOW GUN CHUCK		X	
GAUGED AIR PUMP	X	X	X
SHARP PICK	X	X	X
SHOCK PUMP	X	X	X
SCHRADER VALVE CORE REMOVAL TOOL		X	
STRAP WRENCH		X	
<b>OIL/LIQUIDS</b>			
2.5 , 3, OR 5WT SUSPENSION OIL	X	X	X
GREASE		X	X
OIL MEASURING DEVICE	X	X	X
ISOPROPYL ALCOHOL	X	X	X
BLUE THREADLOCK	X		
RED THREADLOCK			X
FROSTY COLD BEVERAGE	X	X	X

# REAR SHOCK SERVICE

(ARIO - BAR - MC - PEARL)

## INTRODUCTION

Prior to servicing your rear shock, you will first need to remove it from your bicycle frame according to your bicycle manufacture's instructions. Once your shock is off your bicycle, be sure to remove the shock mount hardware.

## AIR CAN REMOVAL/SERVICE INSTRUCTIONS

### GETTING STARTED

Using either your fingers or a pair of pliers, be sure to remove shock mounting hardware.

Spray isopropyl alcohol on entire shock and wipe with a clean rag (not pictured).

### AIR CAN REMOVAL

1. Remove air valve cover cap. Using a small hex wrench or pick, depress schrader valve and release all air from shock. Use a Schrader valve tool to remove the valve core.

**IMPORTANT: TO AVOID INJURY, ALL AIR PRESSURE MUST BE RELEASED FROM SHOCK PRIOR TO REMOVING THE AIR CAN.**

2. Gently secure air can shock eyelet into bench vise.

**NOTE: USE ALUMINUM VISE "SOFT-JAWS" TO PROTECT THE SHOCK EYELET WHEN CLAMPED.**

3. Grip the air can by hand and turn firmly counter-clockwise. Pull the air can up shock damper slowly to remove.

**NOTE: AIR PRESSURE MAY RELEASE, SO HOLD AIR CAN TIGHTLY WHILE PULLING UP.**

4. Remove negative spring spacer and negative spring bumper. Spray both with isopropyl alcohol and wipe with a clean rag.

**IMPORTANT: DO NOT ATTEMPT TO DISASSEMBLE SHOCK DAMPER AND/OR SHOCK EYELET ASSEMBLY. THEY ARE NOT SERVICEABLE.**

5. Using a sharp pick, remove the black rubber dust seal from the air can.

6. Hold air can, narrow end down and remove blue air can glide ring with a sharp pick.

**IMPORTANT: DO NOT SCRATCH THE INSIDE OF THE AIR CAN WITH PICK. SCRATCHES CAN CAUSE PERMANENT AIR BYPASS.**

7. Spray isopropyl alcohol inside air can and wipe with a clean rag. Inspect the inside of the air can for any rough surfaces or scratches. Run your finger along the inside surface of the air can to feel for rough surfaces or scratches as well. Replace air can if scratched or damaged (not pictured).



1

2

3



4

5

6

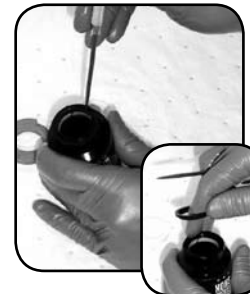
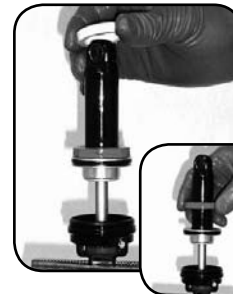

6



## AIR CAN REMOVAL/SERVICE INSTRUCTIONS

8. Remove large fixed air piston o-ring. Apply a few drops of suspension oil to new o-ring and re-install.

**IMPORTANT: THE FIXED AIR PISTON O-RING IS THE MAIN AIR SEAL. BE SURE TO REPLACE THIS O-RING.**

9. Install new air can glide ring and new air can dust seal.
10. Spray isopropyl alcohol on air can threads and eyelet body threads and wipe with a clean rag (not pictured).
11. Apply 2-3 drops of blue threadlock to eyelet body threads, evenly spaced. Spread evenly onto threads and wipe away excess threadlock with a clean rag.
12. Apply a small amount of 5wt suspension oil to the inside of the air can. Using your finger, spread and coat the entire inner air can surface with the oil. Re-apply a few drops of suspension oil to the glide ring and rubber dust seal.
- IMPORTANT: COATING THE INSIDE THE AIR CAN WITH SUSPENSION OIL ENSURES LUBRICATION OF THE FIXED AIR PISTON O-RING, WHICH REDUCES FRICTION AND O-RING WEAR.**
13. Install negative spring bumper and negative spring spacer.
14. Position air can over shock eyelet and slide down on shock body. Press air can down firmly and thread clockwise to tighten into eyelet body as tightly as possible by hand.
- NOTE: ENSURE THE OUTSIDE OF THE AIR CAN IS FREE FROM OIL. THIS ALLOWS MORE LEVERAGE WHEN TIGHTENING AIR CAN ONTO SHOCK EYELET BODY.**
15. Use a Schrader valve tool to re-install the valve core. (not pictured)
16. Using a shock pump, inflate shock to desired air pressure and install valve cover cap (not pictured).
17. Spray isopropyl alcohol on entire shock and wipe with a clean rag (not pictured).
18. Insert mounting hardware into both eyelets (not pictured).

8



9



11



12



13



14



**THIS CONCLUDES THE SPRING SERVICE FOR YOUR SHOCK. YOU DID A GREAT JOB! YOU ARE NOW READY TO RE-INSTALL YOUR SHOCK ONTO YOUR BIKE AND GO FOR A RIDE!**

# REAR SHOCK SERVICE

## (MONARCH)

### INTRODUCTION

Prior to servicing your rear shock, you will first need to remove it from your bicycle frame according to your bicycle manufacture's instructions. Once your shock is off your bicycle, be sure to remove the shock mount hardware.

### SERVICE INSTRUCTIONS

#### GETTING STARTED

Using either your fingers or a pair of pliers, be sure to remove shock mounting hardware (not pictured).

Place an oil pan on the floor underneath the area of the shock. Place a large oil absorbing rag directly underneath the vise where the shock will be clamped to catch all oil that will spill from the shock during service (not pictured).

Turn Rebound Adjuster fully counter-clockwise, toward the rabbit. Switch Gate (if applicable) to the full open, unlocked, position.

#### AIR CAN REMOVAL

1. Remove swivel air valve cap. Using a pick, depressurize air can by depressing valve.
2. Using a Schrader valve tool, remove nitrogen port cap. Using a pick, depressurize nitrogen by depressing valve. Using Schrader valve tool, remove the nitrogen valve core.

**IMPORTANT: TO AVOID INJURY, ALL AIR AND NITROGEN PRESSURE MUST BE RELEASED FROM SHOCK PRIOR TO SERVICING.**

3. Secure shock sideways, by air can shaft eyelet, into bench vise.

**NOTE: USE ALUMINUM VISE "SOFT-JAWS" TO PROTECT THE SHAFT EYELET WHEN CLAMPED.**

4. Grip air can and turn counter-clockwise to unthread. Remove air can.

**TIP: SPRAY ISOPROPYL ALCOHOL ON AIR CAN AND WIPE WITH A CLEAN RAG. THIS WILL HELP WITH GRIP.**

**NOTE: YOU MAY NEED TO USE A STRAP WRENCH TO HELP UNTHREAD THE AIR CAN. IF POSSIBLE, AVOID PLACING STRAP WRENCH ON LOGO STICKER.**

5. Remove the negative spring bumper from inside the air can.

#### SHAFT ASSEMBLY SERVICE

6. Secure body eyelet into vise.

**NOTE: USE ALUMINUM VISE "SOFT-JAWS" TO PROTECT THE BODY EYELET WHEN CLAMPED.**



**1**



**2**

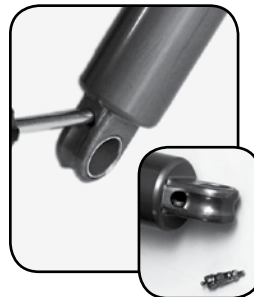

**3**



**4**



**5**



**6**



**6**



## SERVICE INSTRUCTIONS

7. Using a 2 mm hex, unthread and remove bleed screw.

**NOTE: THE WHITE COMPRESSION BALL MAY FLOAT UP THROUGH BLEED HOLE, THIS IS OK. SIMPLY REMOVE BALL FROM BLEED HOLE. YOU WILL BE ABLE TO SKIP STEP 10.**

8. Using an adjustable wrench, loosen and remove shaft assembly from shock body.

**NOTE: OIL WILL SPILL FROM THE SHOCK BODY AND/OR SHAFT ASSEMBLY.**

9. Hold the shaft eyelet with one hand, and push seal head toward air can cap with your other hand to expose bleed hole on underside of seal head.

**NOTE: BE CAREFUL NOT TO PINCH YOUR FINGERS AS YOU SLIDE THE SEAL HEAD.**

10. Using a pick, push and remove the white compression ball out of the backside of seal head through bleed hole.
11. Spray entire shaft assembly with isopropyl alcohol and wipe with a clean rag (not pictured).
12. Using a pick, remove seal head outer glide ring and outer seal. Using a pick remove piston glide ring. Apply a small amount of grease to new seal head outer glide ring and outer seal and piston glide ring and re-install.

### IFP AND SHOCK BODY SERVICE

13. Remove shock body from vise, and pour remaining oil into oil pan.
14. Wrap a rag around end of shock body, insert air compressor chuck into nitrogen fill hole, and force air into body to remove IFP.

**IMPORTANT: USE THE RAG TO CATCH THE IFP AS IT LEAVES THE SHOCK BODY. DO NOT HOLD YOUR HAND OVER OPENING WRAPPED WITH RAG; IT WILL HURT.**

15. Spray isopropyl alcohol on the inside and outside of shock body and wipe with a clean rag. Inspect the inside of the shock body for scratches. (not pictured)
16. Spray IFP with isopropyl alcohol and wipe with a clean rag. Using a pick, carefully remove IFP o-ring. Apply a small amount of grease to new o-ring and re-install.
17. Using a gauge tool, insert IFP into shock body with the stepped side visible. Set IFP height to value indicated in the table below.

**IMPORTANT: MEASURE IFP HEIGHT FROM THE BOTTOM OF THE STEP ON THE IFP.**

SHOCK BODY DIMENSIONS	IFP INSERTION DEPTH
152x31	51 MM
165x38	56 MM
190x51	61 MM
200x51	61 MM
200x57	67 MM
216x63	73 MM
222x66	76 MM





## SERVICE INSTRUCTIONS

### SHOCK REASSEMBLY

18. Using a Schrader valve core tool, install nitrogen valve.
19. Clamp shock by shaft eyelet back into vise.
20. Pour new oil until it is level with the top of the shock body.
21. Slide seal head down against piston.  
**NOTE: BE SURE GATE IS IN FULL OPEN (UNLOCKED) POSITION.**
22. Using a 1.5 mm hex wrench, depress the poppet valve at the bottom of shaft assembly. This will ensure oil entry to the shaft.  
**NOTE: THE POPPET SHOULD NOT REMAIN OPEN.**
23. Holding onto the seal head, place it onto the shock body. Thread shaft assembly onto shock body.  
**IMPORTANT: DO NOT HOLD ON TO THE SHAFT EYELET OR AIR CAN CAP WHILE INSERTING. IT WILL MOVE AND DISPLACE TOO MUCH OIL.**  
**NOTE: OIL WILL DISPLACE OUT OF THE BLEED HOLE.**
24. Using a torque wrench with crow's foot, torque shaft assembly to 250 in/lb.  
**IMPORTANT: INSTALL CROW'S FOOT AT 90° TO TORQUE WRENCH**
25. Insert new white compression ball into bleed hole.
26. Using a 2.5 mm hex, gently thread bleed screw into bleed hole until you feel it touch the white compression ball. Tighten an additional ½ turn.
27. Spray assembly with isopropyl alcohol and wipe with a clean rag (not pictured).
28. Remove shock from vise. Using a gauged pump, pressurize shock body to 250-300psi. Using a Schrader valve tool to re-install nitrogen port cap.
29. Using a pick, remove internal glide ring on air can. Apply a small amount of grease to new glide ring and re-install.
30. Grease the seal head outer glide ring, outer seal, and negative spring bumper (not pictured).
31. Slide negative spring bumper, chamfered side first, onto shock body.
32. Re-clamp shock by shaft eyelet and install air can, twist clockwise while pushing.
33. Install red travel indicator o-ring. (not pictured)
34. Install swivel air valve cap. (not pictured)

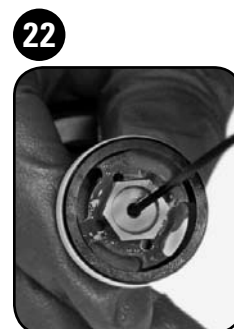
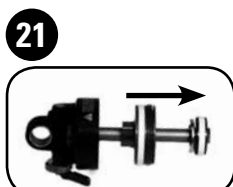
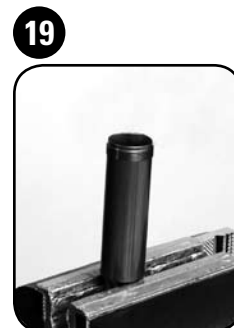
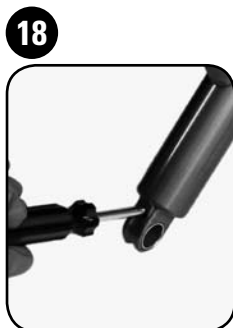

# REAR SHOCK SERVICE

## (VIVID)

### INTRODUCTION

Prior to servicing your rear shock, you will first need to remove it from your bicycle frame according to your bicycle manufacture's instructions. Once your shock is off your bicycle, be sure to remove the shock mount hardware.

### SERVICE INSTRUCTIONS

#### GETTING STARTED (NOT PICTURED)

Using either your fingers or a pair of pliers, be sure to remove shock mounting hardware.

Place an oil pan on the floor underneath the area of the shock. Place a large oil absorbing rag directly underneath the vise where the shock will be clamped to catch all oil that will spill from the shock during service.

Record the adjustment settings for post-service set-up.

Turn the Beginning Stroke Rebound and Ending Stroke Rebound adjustments to the full open position, toward the rabbit. Turn the Low Speed Compression adjustment to the full closed position, toward the turtle.

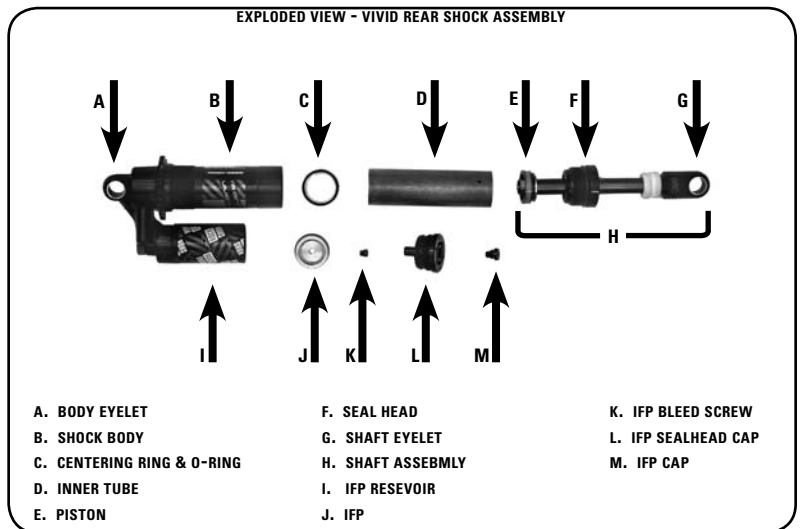

- #### SPRING REMOVAL
1. Turn pre-load collar counter-clockwise until it stops.
  2. Remove spring retainer, spring and drop stop. Set aside parts until Shock Bleed & Reassembly section.

**NOTE: THE DROP STOP HOUSES A BUMPER WHICH WILL NOT BE REMOVED FROM THE SHOCK.**

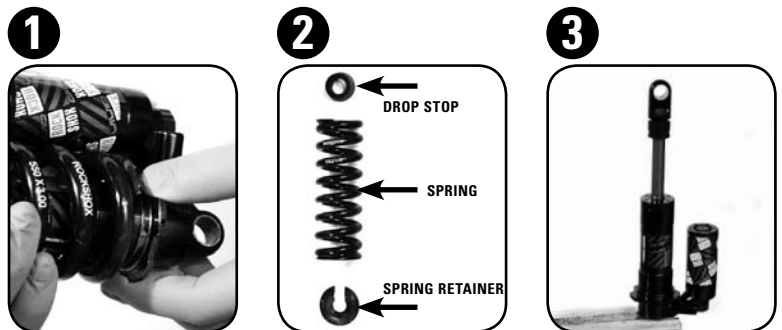

- #### SHOCK BODY DISASSEMBLY
3. Clamp shock by body eyelet into vise.
  4. Using a T-10 Torx, remove the IFP cap from the IFP reservoir and discharge air by depressing the valve. Using a Schrader valve tool, remove the Schrader valve core.

**IMPORTANT: BE SURE TO COMPLETELY DISCHARGE THE IFP RESERVOIR TO AVOID PERSONAL INJURY DURING DISASSEMBLY.**

5. Using the RockShox 24 mm pin spanner, unthread the seal head.
- IMPORTANT: HOLD THE PIN SPANNER HEAD IN PLACE WITH YOUR OPPOSITE HAND DURING USE TO AVOID DAMAGING THE SEAL HEAD PIN HOLES.**

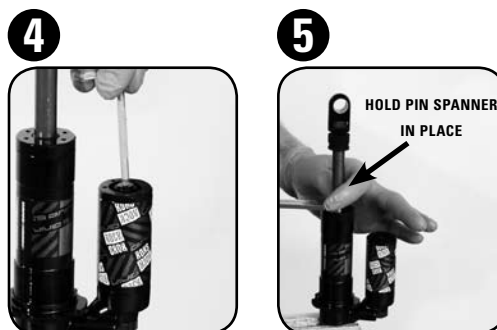

## SERVICE INSTRUCTIONS (CONT)

6. Pull up on seal head and remove entire shaft assembly.

**NOTE: THE SHOCK BODY INNER TUBE MAY BECOME DISLODGED WITH THE SHAFT ASSEMBLY; THIS IS OK. IF THIS OCCURS, SIMPLY SEPARATE THE SHAFT ASSEMBLY FROM THE INNER TUBE AND REMOVE THE INNER TUBE FROM THE SHOCK BODY.**

7. Using your fingers, remove inner tube from shock body.

8. Remove shock from vise and pour all oil from shock into oil pan (not pictured).

9. Confirm that the centering ring, located in the bottom of the shock body, is still in place (not pictured).

**NOTE: THE CENTERING RING MAY BECOME DISLODGED WHEN REMOVING THE INNER TUBE, THIS IS OK. IF THIS OCCURS, SIMPLY SEPARATE CENTERING RING FROM THE INNER TUBE AND REMOVE FROM THE SHOCK BODY.**

10. Clamp pick into vise. Slide the shock body over pick. Using the pick as a hook, gently catch the bottom of the centering ring and pull back on the shock body to dislodge the centering ring. You may have to hook the pick around the centering ring in several places in order to dislodge.

**IMPORTANT: DO NOT TO SCRATCH THE BOTTOM OF THE SHOCK BODY WITH THE PICK; THIS IS THE SEALING SURFACE. DAMAGE TO THIS SURFACE WILL INTERFERE WITH THE PERFORMANCE OF THE SHOCK.**

### SHOCK BODY SHAFT ASSEMBLY SERVICE

11. Spray shaft assembly with isopropyl alcohol and wipe with a clean lint-free rag (not pictured).

12. Using the RockShox shaft clamp tool, clamp the shaft assembly into the vise.

**NOTE: SPRAY ISOPROPYL ALCOHOL ON SHAFT CLAMP AND WIPE WITH A CLEAN RAG PRIOR TO USE.**

13. Using a pick, remove glide ring on the main piston. Apply a small amount of grease to new glide ring and re-install.

14. Using a 13 mm wrench, unthread piston bolt. Carefully remove main piston assembly (piston bolt, main piston, and shim stack washers), keeping all parts together and set aside.

15. Firmly pull up on seal head and remove.

16. Using a pick, remove the shaft wiper seal and main shaft o-ring located in the interior of the seal head. Remove the quad ring top out pad located on the backside of the side head. Apply a small amount of grease to new shaft wiper seal, main shaft o-ring and quad ring top out pad and re-install.

17. Inspect the body seal o-ring located on the underside lip of the seal head for wear or damage. Replace if necessary.

18. Set aside seal head and main piston assembly (not pictured).

6



7



10



12



13



14



15

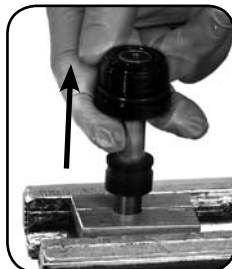

16



17



## SERVICE INSTRUCTIONS (CONT)

19. Flip shaft assembly in shaft clamp so shaft eyelet is accessible. Using 13 mm wrench, unthread the eyelet and remove.
20. Clean Loctite from threads of shaft eyelet (not pictured).
21. Using a pick, carefully push the red Beginning Stroke Rebound Adjuster knob out of the shaft eyelet.

**NOTE: THE BEGINNING STROKE REBOUND ADJUSTER KNOB HOUSES THE DETENT BALL AND SPRING. BE CAREFUL NOT TO LOSE THESE PARTS.**

22. Using a pick, remove the Beginning Stroke Rebound Adjuster knob o-ring. Apply a small amount of grease to new o-ring and re-install.
23. Using a crescent wrench, unthread the rebound needle and remove.

**IMPORTANT: BE VERY CAREFUL NOT TO DAMAGE THE HEX ON THE REBOUND NEEDLE WITH THE CRESCENT WRENCH.**

24. Using a pick, remove the rebound needle o-ring. Apply a small amount of grease to new o-ring and re-install. Set aside rebound needle.
25. Carefully insert detent spring followed by detent ball into the offset hole in the shaft eyelet. Slide rebound knob, with detent features interfacing with the detent ball, back into shaft eyelet. Set aside shaft eyelet.

26. Flip shaft assembly in shaft clamp so rebound bleed port is accessible. Grease interior of seal head and install on shaft assembly with seal head threads oriented up toward you.

**IMPORTANT: MAKE SURE THE SHAFT WIPER SEAL DOES NOT FOLD OVER WHEN INSTALLING SEAL HEAD.**

27. Using a 13 mm wrench, thread piston assembly back onto shaft assembly and torque to 70 in-lbs.

28. Flip shaft assembly in shaft clamp so shaft eyelet threads are exposed. While pushing down, thread rebound needle into shaft by hand until it stops.

29. Clean shaft assembly threads with alcohol. Place a couple of drops of red Loctite on threads.

**IMPORTANT: BE SURE LOCTITE DOES NOT GET BETWEEN REBOUND NEEDLE AND SHAFT. IT WILL PREVENT THE NEEDLE FROM MOVING.**

30. Clean shaft eyelet threads with alcohol (not pictured).

31. Holding the shaft eyelet assembly by the eyelet, thread shaft eyelet assembly onto shaft.  
**IMPORTANT: DO NOT HOLD THE BEGINNING STROKE REBOUND KNOB WHILE THREADING THE SHAFT EYELET ASSEMBLY.** After approximately 4 full turns, you will hear an audible clicking sound, indicating the rebound needle has engaged the adjuster knob. Continue to thread shaft eyelet assembly by hand until tight. Using a 13 mm wrench to 130 in-lbs.

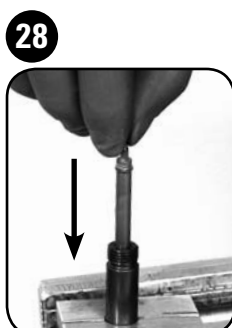
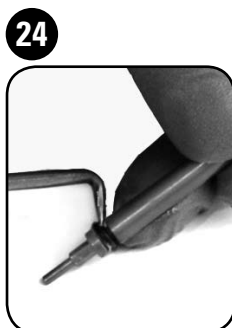
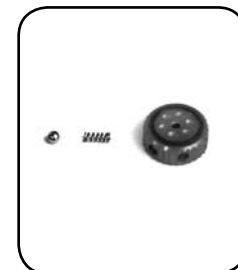

## SERVICE INSTRUCTIONS (CONT)

32. Remove shaft assembly from vise and set aside until Shock Bleed & Reassembly section (not pictured).

### IFP RESERVOIR & LOW SPEED COMPRESSION VALVE SERVICE IFP RESERVOIR SERVICE

33. Clamp shock body by the body eyelet into vise. Using a 30 mm flat wrench at the base of IFP reservoir (to keep the reservoir from spinning) and a 24 mm pin spanner wrench on the top of the reservoir, unthread the IFP seal head cap and remove.

**IMPORTANT: HOLD THE PIN SPANNER HEAD FLAT AGAINST THE SEAL HEAD CAP DURING USE TO AVOID DAMAGING THE PIN HOLES.**

34. Inspect IFP seal head o-ring for damage. Replace if necessary.

35. Using a 30 mm flat wrench at the base of the IFP reservoir, unthread and remove the IFP reservoir.

**NOTE: THE IFP MAY BECOME DISLODGED FROM THE IFP RESERVOIR; THIS IS OK. IF THIS OCCURS, SIMPLY REMOVE THE IFP FROM THE IFP RESERVOIR.**

36. Using your finger, push the IFP out of the IFP reservoir from the backside.

37. Using a pick, remove blue glide ring and main seal o-ring from the IFP. Apply a small amount of grease to new glide ring and o-ring and re-install.

38. Using a T-10 Torx, remove IFP bleed screw. Using a pick, remove IFP bleed screw o-ring. Apply a small amount of grease to new o-ring and re-install.

39. Set aside IFP reservoir, IFP, and IFP bleed screw until Shock Bleed & Reassembly section (not pictured).

### LOW SPEED COMPRESSION VALVE SERVICE

40. Using a 2 mm hex, remove the low speed compression knob.

**TIP: YOU DO NOT NEED TO COMPLETELY REMOVE THE RETAINING SCREW TO REMOVE THE KNOB.**

41. Squeeze the Low Speed Compression valve assembly between your fingers, and carefully push it up and out of the body side IFP reservoir.

**NOTE: CONTINUE TO SQUEEZE THE COMPRESSION VALVE ASSEMBLY TOGETHER AS YOU REMOVE; IT HOUSES THE DETENT BALL AND SPRING. BE CAREFUL NOT TO LOSE THESE PARTS.**

42. Inspect body side IFP reservoir o-ring for damage. Apply grease to new o-ring and replace if necessary.

43. Separate inner knob and detent ball and spring, from Low Speed Compression valve assembly. Slide shim check spring off valve assembly.

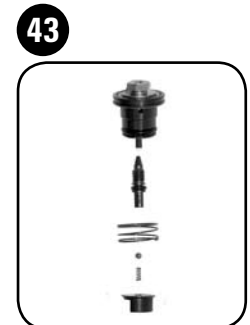
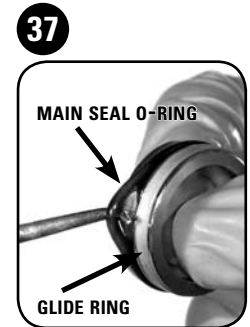

## SERVICE INSTRUCTIONS (CONT)

44. Using your fingers, unthread compression needle from the back of the Low Speed Compression valve assembly.
45. Inspect check shim for damage and replace if necessary.

**IMPORTANT: IF THE CHECK SHIM NEEDS TO BE REPLACED, DO NOT USE A PICK TO REMOVE. INSTEAD, USE YOUR FINGERNAIL TO REMOVE TO AVOID DAMAGING THE VALVE SEALING SURFACE.**

46. Remove the Low Speed Compression valve main o-ring, compression piston o-ring, and compression needle o-ring. Apply grease to new main, compression, and needle o-rings and re-install.

47. Remove shock from vise and pour out any remaining oil. Clamp shock by body eyelet back into vise (not pictured).

48. Using your fingers, thread compression needle back into Low Speed Compression valve assembly.

49. Slide shim check spring onto assembly. Using a dab of grease to hold parts together, insert detent spring followed by detent ball into inner knob.

50. Install inner knob onto compression needle and hold entire assembly together by squeezing it between your fingers.

51. Carefully insert low speed compression valve assembly into shock body, inner knob first.

**TIP: USE YOUR LITTLE FINGER TO HELP GUIDE THE LOW SPEED COMPRESSION VALVE ASSEMBLY INTO PLACE.**

**IMPORTANT: MAKE SURE THE LOW SPEED COMPRESSION VALVE ASSEMBLY IS FULLY SEATED. BE CAREFUL NOT TO DAMAGE THE MAIN O-RING.**

52. Hand thread IFP reservoir onto shock body until it is tight.

**IMPORTANT: MAKE SURE THERE IS NO GAP BETWEEN THE IFP RESERVOIR AND SHOCK BODY.**

53. Using a 2 mm hex, re-install low speed compression knob.

### ENDING STROKE REBOUND SERVICE

54. Clamp shock into vise sideways by body eyelet so the Ending Stroke Rebound adjuster is easily accessible. Using a 2.5 mm hex, turn the Ending Stroke Rebound adjuster 5 clicks from fully open.

55. Using a pick, remove Ending Stroke Rebound retaining ring.

44



45



46



48



49



50



51



52



53



54



55



## SERVICE INSTRUCTIONS (CONT)

56. Using a 2.5 mm hex unthread the Ending Stroke Rebound adjuster screw and remove.

**IMPORTANT: THE ENDING STROKE REBOUND ADJUSTER HOUSES TWO DETENT BALLS, THE DETENT SPRING, HIGH SPEED REBOUND COIL SPRING AND PLUG, AND TWO SHIMS. BE CAREFUL NOT TO LOOSE THESE PARTS.**

57. Remove Ending Stroke Rebound adjuster screw o-ring. Apply grease to new o-ring and re-install.

58. Replace rebound shims.

59. Using a dab of grease to hold parts together, stack the 6 mm shim (narrow shim) onto rebound plug, followed by 7 mm shim (wider shim). Carefully drop rebound plug, shims first, into rebound hole. Insert High Speed Rebound coil spring on top of rebound plug.

**TIP: GENTLY SEAT THE REBOUND PLUG INTO PLACE WITH A PICK.**

60. Grease Ending Stroke Rebound adjuster screw. Insert detent spring into hole, followed by detent balls into holes on either side. Use a dab of grease to keep the detent balls in place.

61. Carefully insert Ending Stroke Rebound adjuster screw into Ending Stroke Rebound housing. Using a 2.5 mm hex, thread until it stops. All parts are properly seated when you hear 'clicking' sounds.

**IMPORTANT: YOU DON'T WANT TO FEEL THE PARTS BINDING AS YOU THREAD ADJUSTER SCREW INTO PLACE. IT SHOULD REMAIN SMOOTH UNTIL IT STARTS TO CLICK. IF THE PARTS BIND, IT MEANS ONE OF THE DETENT BALLS CAME UNSEATED AND YOU WILL NEED TO RE-DO THIS STEP.**

62. Using your fingers, re-install Ending Stroke Rebound retaining ring.

63. Using a 2.5 mm hex, turn the Ending Stroke Rebound adjuster fully counter-clockwise, toward the rabbit to ensure the retaining ring is fully seated.

### SHOCK BLEED & RE-ASSEMBLY PROCEDURES

64. Clamp shock by body eyelet so the shock body and IFP reservoir are accessible.
65. Grease the o-ring groove of the Centering Ring and re-install the face seal o-ring, smoothing grease over the o-ring to keep it in place. Using the inner tube as a push rod, press the Centering Ring, o-ring side down, into the bottom of the shock body.
66. Using a 2.5 mm hex, ensure the Ending Stroke Rebound Adjuster is turned fully counter-clockwise, toward the rabbit (not pictured).
67. 5.1 ONLY: Turn the Low Speed Compression Knob fully counter-clockwise, away from "+" sign (not pictured).

56



57



58

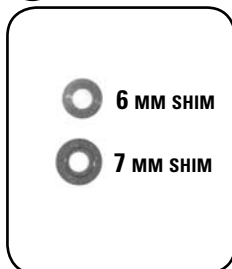

59



60



61



62



63



64



65



## SERVICE INSTRUCTIONS (CONT)

68. Using 3wt oil (or high grade 2.5wt), fill the IFP reservoir to the top. Oil will gradually flow from the IFP reservoir into the shock body through the small port located at the bottom of the IFP reservoir. Continue to fill IFP reservoir until the oil level in the shock body reaches approximately 25 mm in depth.
69. Begin the reverse process of pouring oil into the shock body. Continue until oil starts to overflow out of the IFP reservoir. This procedure effectively dislodges air bubbles from the system. Top off the oil in the shock body in order to continue oil flow from the shock body to the IFP reservoir.
70. Gently slide the IFP, step side down, on top of the IFP reservoir. Let the IFP 'float' on top of the oil in IFP reservoir.
71. Cover the bleed hole on the IFP with your thumb to create a seal and firmly push the IFP down into the IFP reservoir approximately 12 mm.  
**NOTE: YOU WILL FEEL THE IFP O-RING 'ENGAGE' THE WALL OF THE IFP RESERVOIR ONCE IT IS PAST THE THREADS.**
72. Top off the oil in the shock body again in order to continue oil flow from the shock body to the IFP reservoir.  
**IMPORTANT: WAIT FOR THE OIL TO OVERFLOW FROM THE IFP RESERVOIR BEFORE CONTINUING.**
73. Using the T-10 Torx, install the IFP bleed screw. Tighten until the IFP spins.
74. Using the T-10 Torx as a push rod, firmly push the IFP down into IFP reservoir until it stops, approximately 45.5 mm from top of IFP reservoir.
75. Insert the shock body inner tube into the shock body with the cross holes up toward the opening.  
**IMPORTANT: IT IS CRITICAL THAT THE CROSS HOLES ARE FACING UP TOWARD THE SHOCK BODY OPENING.**
76. Gently wiggle the inner tube side to side against the shock body with your finger to dislodge any air bubbles between the two walls.
77. Top off oil in the shock body one last time.
78. Seat the seal head fully against the piston of the shaft assembly. Place the piston in oil on top of the shock body at a 45 degree angle. Rotate the shaft assembly 2-3 times to cover the piston assembly in oil. Continue to rotate the shaft assembly as you align it vertically, and gently insert the assembly into the shock body. This process minimizes trapped air during the assembly process.

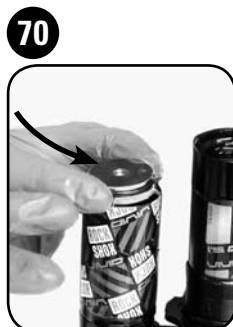



## SERVICE INSTRUCTIONS (CONT)

79. Hold the shaft assembly by the seal head and **slowly** thread the seal head onto the shock with your fingers. Trapped air and oil should escape thru the notch in the seal head threads.

**IMPORTANT: DO NOT THREAD OR PUSH ON THE SHAFT ASSEMBLY FROM THE SHAFT EYELET. THIS COULD DISPLACE MORE OIL THAN IS NECESSARY AT THIS TIME.**

**IMPORTANT: BE SURE TO PERFORM THIS STEP SLOWLY, ALLOWING OIL AND AIR TO ESCAPE THRU THE NOTCH.**

80. Continue to thread the seal head down until the seal head o-ring is engaged. Using the 24 mm pin spanner tool, torque the seal head to 250 in-lbs.

**NOTE: FIRMLY HOLD THE 24 MM PIN SPANNER IN PLACE WITH ONE HAND WHILE TORQUING WITH THE OTHER.**

**IMPORTANT: THE TORQUE WRENCH SHOULD BE ATTACHED AT A 90 DEGREE ANGLE TO THE 24 MM PIN SPANNER TOOL IN ORDER TO OBTAIN AN ACCURATE TORQUE MEASUREMENT.**

81. Remove the shock from the vise and pour out any excess oil that is remaining above the IFP.

**IMPORTANT: FAILURE TO REMOVE THIS EXCESS OIL WILL REDUCE THE IFP VOLUME AND LIMIT SHOCK TRAVEL.**

82. Clamp the shock back into the vise at the Body Eyelet and install the IFP reservoir seal head. Using the 24 mm pin spanner tool, torque to 100 in-lbs.

**IMPORTANT: THE TORQUE WRENCH SHOULD BE ATTACHED AT A 90 DEGREE ANGLE TO THE 24 MM PIN SPANNER TOOL IN ORDER TO OBTAIN AN ACCURATE TORQUE MEASUREMENT.**

83. Install the Vivid air adapter onto a gauged pump, and charge the IFP chamber to:

Shock Model	Pressure
Vivid 5.1	200psi (13.8 bar)
Vivid 4.1	230psi (15.9 bar)

79



80



81



82



83



84



84. Using a T-10 Torx®, install the IFP end cap onto the reservoir.

85. Spray the entire shock with alcohol and wipe clean with a lint free rag (not pictured).



## **COPYRIGHT**

All content included in this catalog, including but not limited to text, graphics or images is copyrighted as a collective work under the United States and other copyright laws, and is the property of SRAM Corporation. Copyright 2007, SRAM Corporation. ALL RIGHTS RESERVED. Any other use, including but not limited to the reproduction, distribution, display or transmission of this content of this catalog is strictly prohibited. Other names of products and companies mentioned in this catalog may be the trademarks of their respective owners.

All information and specifications in this catalog are subject to change without notice.

The following are trademarks or registered trademarks of SRAM Corporation in the United States and other countries:

SRAM, RockShox, Avid, Truvativ, 1:1, Grip Shift, Torpedo, U-Turn, Bar, BoXXer, Pike, SID, Reba, BlackBox, Climb It Control, Tullio, Juicy, Single Digit, Speed Dial, Arch Rival, Black Ops, Flak Jacket, Full Metal Jacket, Hussefelt, Holzfeller, Luftalarm, Stylo, Firex, IsoFlow, Touro, Giga Pipe, FiveD, Isis Drive (design), Wavo, X.0, X.9, X.7, 5.0, 4.0, 3.0, SX4, SX5, 1:1 Actuation Ratio, TRX, Attack, Rocket, SRAM Rocket, Centera, MRX, PowerChain, PowerGlide, PowerLink, PowerLock, SaltShaker, Impulse Technology, Thumbs Up, Zero Loss Travel, C3 Composite, Zero Loss Travel, Cable Cradle, StraightShot, Uni-Lever, Quick View, i-LIGHT, i-BRAKE, i-MOTION, i-MOTION 3, i-MOTION 9, Sparc, S7, P5, T3, DualDrive, TwinDrive, Bandix, Force, Rival, DoubleTap, HCT, OCT, Exact Actuation, Mission Control, 2-Step, Maxle, Maxle 360, Solo Air, Dual Air, TurnKey, IsoLite, IsoLite Cushion, Air U-Turn, Rear Maxle, PopLoc, PopLoc Dual, PopLoc Adjust, PushLoc, Ario, Pearl, MC, Argyle, Domain, Totem, Lyrik, revelation, Recon, Tora, Dart, Code, Ultimate, Shorty, Force Vector Alignment, BB5, BB7, FR5, Boxguide, Shiftguide, Engineering the shift, XR, Team, LE, 3D, XR 3D, Team 3D, Rouleur, Team BMX, Racing XR, Racing Team, Racing Junior, Ruktion, Noir, Blaze, 5D, X-Flow, Elita, Power Spline, GXP, Giga X Pipe, ISIS, Overdrive, Square LE, Howitzer, Beyond Performance and Innovative Bicycle Components.

### **WORLD HEADQUARTERS**

SRAM Corporation  
1333 N. Kingsbury, 4th Floor  
Chicago, Illinois 60622  
United States of America  
Phone: +1-312-664-8800  
Fax: +1-312-664-8826  
E-mail: sramusa@sram.com

### **ASIAN HEADQUARTERS**

SRAM Taiwan  
No. 1598-8 Chung Shan Road  
Shen Kang Hsiang, Taichung  
County 429 Taiwan R.O.C.  
Phone: +886-4-2561-3678  
Fax: +886-4-2561-3686  
E-mail: sramasia@sram.com

### **EUROPEAN HEADQUARTERS**

SRAM Europe  
Basicweg 12-D  
3821 BR Amersfoort  
The Netherlands  
Phone: +31-33-450-6060  
Fax: +31-33-457-0200  
E-mail: srameurope@sram.com

[www.sram.com](http://www.sram.com)

**world headquarters**

SRAM corporation  
1333 n. kingsbury st., 4th fl  
chicago, il 60622  
phone +1-312-664-8800  
fax +1-312-664-8826

**european headquarters**

SRAM europe  
basicweg 12-d  
3821 br amersfoort  
the netherlands  
phone +31-33-450-6060  
fax +31-33-457-0200

**asian headquarters**

SRAM taiwan  
no. 1598-8 chung sahn rd  
shen kang hsiang, taichung  
county 429 Taiwan R.O.C.  
phone +886-4-2564-3678  
fax +886-4-2561-3686